

# radio service dealer

JULY, 1947

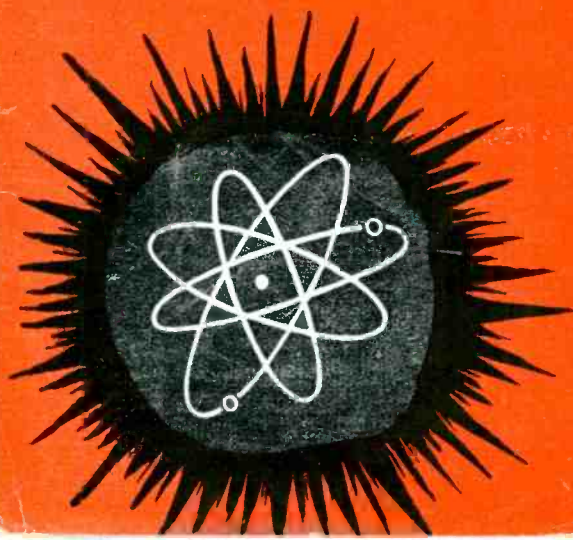

*In This Issue:*

**TELEVISION QUIZ**

**FREQUENCY MODULATION FUNDAMENTALS**

**AGC CIRCUITS IN TELEVISION RECEIVERS**

**USING A CONVENTIONAL SIGNAL GENERATOR  
IN FM ALIGNMENT**

**Four Out of Five Auto Radios Have It\***

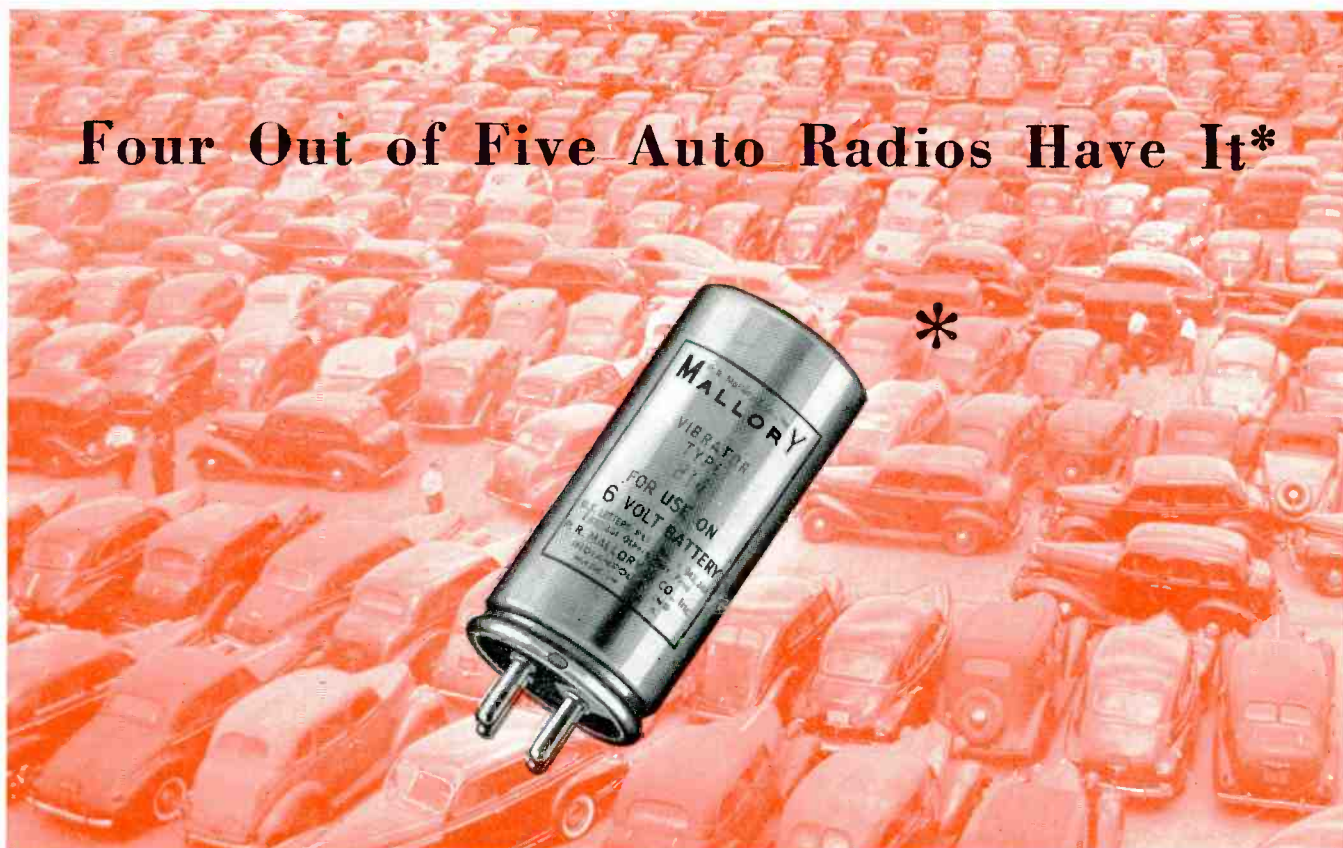

***That's Why the Mallory Vibrator Makes the Best Replacement***

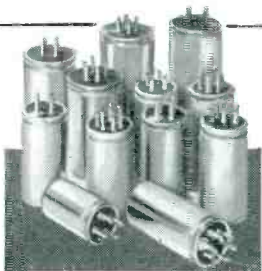

**Mallory Has the Most Complete Vibrator Line**

The 12 basic vibrators illustrated above answer 90% of your replacement requirements. But Mallory offers 50 vibrators in all so that every need can be instantly met. The Mallory line is the most complete in the business.

More Mallory vibrators are in use today than all other makes combined. In the field of auto radio alone, four sets out of every five carry Mallory vibrators *as original equipment*. Why?

Because Mallory is the world's largest producer of vibrators—has learned the "hard way" how to make vibrators. Because Mallory has introduced many vibrator "firsts" . . . has patented more than 50 improvements . . . adheres to the strictest production standards in the vibrator industry.

These are good and sufficient reasons, too, why Mallory vibrators make *the best replacements*. You can't do better, when you service a set than to use a Mallory replacement.

*See Your Mallory Distributor for a free copy of the 1947 Replacement Vibrator Guide*

**P. R. MALLORY & CO., Inc.**  
**MALLORY**

VIBRATORS . . . VIBRAPACKS\* . . . CAPACITORS . . . VOLUME CONTROLS . . . SWITCHES . . . RESISTORS . . . FILTERS . . . RECTIFIERS . . . POWER SUPPLIES.

\*Reg. U. S. Pat. Off.

**APPROVED PRECISION PRODUCTS**

**P. R. MALLORY & CO., Inc., INDIANAPOLIS 6, INDIANA**

**"I find by comparison  
there is no comparison—"**

**PHOTOFACT<sup>\*</sup> is  
by far superior  
in all ways"**

—E. S. Worthington, Jr.  
Maplewood, Missouri  
(In Radio Servicing Since 1929)

Hundreds of OLD TIME Radio Service Men have made the same comparison, and like Mr. Worthington they've found helpful, time saving, profit making, exclusive advantages in PHOTOFACT that no other service can provide.

It's like trying to compare an encyclopedia with a dictionary.

Make the test for yourself.

**You'll find these EXCLUSIVE  
PHOTOFACT ADVANTAGES**

● **MOST ACCURATE**

Based on study of the actual equipment in our own laboratories.

● **MOST COMPLETE**

Gives you all the data you need.

● **MOST UNIFORM**

Data is always in the same place—easiest for fast reference.

● **DIAL CORD DRAWINGS**

For EVERY receiver.

● **PRODUCTION CHANGES**

The only service that is always up-to-date.

● **CODED SCHEMATICS**

For every receiver, keyed to complete parts lists and photographs.

● **PHOTOGRAPHS**

Top—bottom and other views of EVERY instrument—LARGE—CLEAR with each part coded.

\*Reg. U. S. Pat. Off.

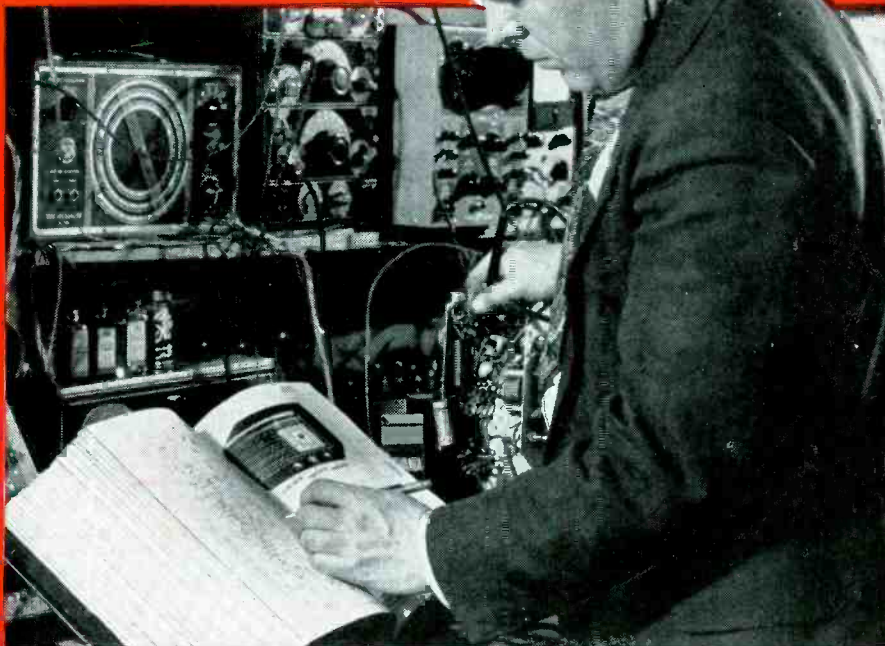

Ask to see PHOTOFACT VOLUMES I and II. Notice these points. The same complete data always in the same easy-to-find location! BIG, CLEAR, ACCURATE PICTURES—each with its simple coding system—keyed for instant reference to complete parts lists. Full alignment and circuit data! DISASSEMBLY INSTRUCTIONS! DIAL CORD DRAW-

INGS! And even RECORD CHANGERS are completely diagrammed.

Put any other service beside PHOTOFACT and compare. Use PHOTOFACTS once—you'll use them forever.

Individual Set #21—available July 15 at the same low cost of \$1.50. Order Volumes I and II and the current set from your nearest distributor, or mail directly to us.

**COMPARE ... and You'll Buy PHOTOFACT**  
**HOWARD W. SAMS & CO., INC.**

INDIANAPOLIS 6, INDIANA

Export—Ad. Auriema—89 Broad St., New York 4, N. Y.—U. S. of America

Canada—A. C. Simmonds & Sons, 301 King St. East—Toronto, Ontario

**PHOTOFACT SERVICE**

**"The Service that pays for itself over and over again"**

**HOWARD W. SAMS & CO., INC.**  
Indianapolis 6, Indiana

My (check) (money order) is enclosed.

Send \_\_\_\_\_

Name \_\_\_\_\_

Address \_\_\_\_\_

City \_\_\_\_\_ State \_\_\_\_\_

PHOTOFACTS are based on OUR actual study of the equipment covered. We ORIGINATE information—WE DO NOT COPY IT. Every fact is quadruple checked for accuracy. NO OTHER SERVICE COMPARES WITH PHOTOFACT.

PHOTOFACT VOLUMES I and II—the first 20 sets of PHOTOFACT Folders—are now available. Think of it! Almost 3800 pages, covering approximately 1800 NEW 1946 and 1947 models and chassis designations—yours for only \$18.39 for each volume. If you prefer drawer filing, order any or all of the 20 individual sets of folders at \$1.50 per set. Less than two cents a model brings you this complete, up-to-the-minute service.





## TAKE A LEAF FROM THE OLD-TIME RIVER PILOT'S BOOK... AND LET THE CURRENT HELP CARRY YOU!

**P**ROFITS? SUCCESS? . . . You'll gain them faster—and with a lot less effort—if you keep your business craft in the swift-flowing current of G-E product-popularity.

It's smart to install and sell G-E radio tubes because they're top-quality *and the world knows it*. That's the impelling force that backs up your efforts as a G-E tube dealer—helps bring you new customers, leads present clients to recommend your shop to their friends.

Plenty of muscle, too, in the "lift" you're given by General Electric along promotion lines! The finest tube dealer-aid material in the industry is supplied for 1947. Also, your prospects see G.E.'s full-color national electronics advertis-

ing in magazines read by millions—advertising that guides buyers straight to your shop door.

Quality, reputation, strong and continuous promotion—these are high cards in any business. They're yours for the asking, when you install and sell G-E radio tubes. They will make your sales hand a winning one, with steady, ever-growing volume and profits. *Electronics Department, General Electric Company, Schenectady 5, New York.*

You want and need Sales-helps Booklet ETR-51, describing G.E.'s complete line of displays and other promotion material available to service-men and tube dealers. Send for your free copy TODAY.



## RADIO TUBES



# GENERAL ELECTRIC

176-F7-8850

FIRST AND GREATEST NAME IN ELECTRONICS

# EDITORIAL

## Petrillo Squelch Boon To FM

Many FM broadcast stations have been all ready but have not gone into operation pending the Supreme Court's decision on the Lea "Anti-Petrillo" act. Now, because broadcasters know they will not be forced to pay salaries to many extra musicians who merely "stand-by," their FM stations will be opened. FM stations in the main have been programming phonograph recordings and but few have carried the most popular so-called "big name" broadcasts. FM's two biggest weaknesses have been inferior quality (entertainment) programs and an insufficient number of functioning stations. The cause of both of these short-comings was in great part directly traceable to Petrillo's edicts. We expect FM to now boom at a terrific clip from Coast-to-Coast and in the smaller communities especially. And, as all Service Dealers will derive a great part of their livelihood from FM in future, our text section will concentrate to a greater extent than ever before on this relatively embryonic subject.

## Our Subscriber Survey

Within the past 90 days each of "RSD's" 19,000 subscribers received a questionnaire form from us. In it we asked such questions as these: Do you own your own business or are you working for someone? Does your establishment sell such items as radio sets, appliances, etc., and does it operate its own service department, or is your firm engaged solely in doing service and repair work? To check the answers to the several questions and then mail the form back to us in the postage-paid envelope sent with it takes only a few minutes at most. The great majority of our subscribers gave us 100% cooperation and complied with our first request immediately. To those who did not, we have sent a "Second Request" and we sincerely urge you to give us the data we ask for.

Frankly, by knowing what our subscribers do, what type of business their firm is engaged in, and all that — we as publishers are greatly aided. Such information guides our editors so they are then able to provide better articles that will prove more helpful to all our readers. We thank each of you for your cooperation and promise that any information you give is kept in strictest confidence and is used primarily in your own interests.

## Bright Outlook for All

Many "RSD" subscribers reside in the rural areas where FM and television are still 'futures'. Yet these urbanites can be complacent in the knowledge that within five years upwards of four million new homes must be built and two and a quarter million rural homes not having modern electrical conveniences will be wired. Yet from the battery maker's point of view prospects aren't at all bad, for the new 3-way and personal radios reaching the field are being gobbled up at an amazing rate. And for bobby-soxers, even battery-operated phonographs are in the offing.

S. R. COWAN, Publisher



Member of the  
Audit Bureau of  
Circulations



VOL.  
8  
No.  
7

SANFORD R. COWAN

Editor & Publisher

JULY, 1947

Editorial .....	3
In & Around The Trade .....	4
Television Quiz .....	10
Ascertain how much you know about television fundamentals	
Frequency Modulation, Part I .....	12
Starting a series covering FM completely	
Automatic Gain Control Circuits In Television Sets, by S. L. Marshall .....	14
An analysis of most popular AGC circuits	
Using a Conventional Signal Generator in FM Alignment, by S. Terrell .....	18
How a conventional but not sweep sig. gen. is usable	
Shop Notes .....	22
New Products .....	24

SANFORD L. CAHN  
National Advertising Sales Manager

HARRY N. REIZES  
Advertising Manager

BRANCH: JAMES C. GALLOWAY, 816 W. 5th St., Los Angeles 13, Calif. Mutual 8335

Jean M. Wheeler  
Circulation Manager

David Saltman  
Adv. Production Manager

RADIO SERVICE DEALER (title registered U. S. Pat. Off.) is published monthly at Boston Post Road, Orange, Connecticut, by the Cowan Publishing Corp. Executive & Editorial Offices, 342 Madison Avenue, New York City 17, New York. Publication Office, Boston Post Road, Orange, Conn. Subscription rates: —United States, U. S. Possessions and Canada, \$2.00 for 1 year, \$3.00 for 2 years; elsewhere \$3.00 per year. Single copies: 25¢. Printed in U. S. A. Entered as Second Class Matter at the Post Office at Orange, Connecticut, under the Act of March 3, 1879. All subscribers should allow at least three weeks for change of address. Copyright, 1947.

COWAN PUBLISHING CORP.

# In & Around the Trade

Being a condensed digest of production, distribution and merchandising activities in the radio and appliance trade.

## Radios by Electronic Labs

One of a new line of radios being made by Electronic Laboratories, Inc., Indianapolis (mark the first time the firm has gone into large scale radio production) incorporates an electric "lift" for the automatic record player. When you want the record player, you simply push a button and presto—there it is. The whole top of the radio rises too so you've got a handy place to put your record albums. Press the button again and the record player is gone.

With the brand name "Orthosonic", these new receivers are keyed around a special amplifier-speaker system permitting individual adjustment of high and low notes to suit the listener's preference.

Models range from the Chairside combination with the built-in "elevator" to small table models. There's also a combination radio and intercom in one for the businessman. But it's made to look only like an intercom, in case the boss wants to hear the baseball games without letting the rest of the office know.

Webster-Chicago is offering dealers a sales aid in the form of a permanent display case for the Nylon Phonograph Needle. In clear plastic, it takes up very little space, can be used on counter, in show case or may be hung on a wall. This display is furnished free to dealers handling the Webster Nylon Needle. Information will be supplied by Webster-Chicago Corporation, 5610 Bloomingdale, Chicago 39, Illinois.



## Stewart-Warner Ups Advertising

In the belief that 1947 will be "a buyers' year on radio sets", Stewart-Warner Corporation is "more than doubling" its 1946 advertising and merchandising program, according to Leo B. Pambrun, advertising manager for the Radio division of the company.

"Anticipating that 1947 will be a buyers' year," Mr. Pambrun stated, "Stewart-Warner has planned an advertising and merchandising program more than doubling the outstanding effort made for its dealers in 1946. Displays, identification signs, and real feature-selling literature are now in preparation for the all-new models recently introduced and full line schedules have been released for color pages in such national magazines as Saturday Evening Post, Colliers, Time, New Yorker. Dealers will be well informed of latest Stewart-Warner developments via full page ads in all leading radio and appliance trade journals; also doubled down the line this year will be dealer merchandising aids. A comprehensive cooperative program in newspapers and other local media, with distributors and dealers participating is included."

## Television Sets in the West

Beginning in March the first television receivers to be introduced in the Los Angeles area in substantial quantities came in several carloads.

These sets feature the RCA Victor Eye Witness Picture Synchronizer—a new scientific development in television receiver design which locks the receiver in tune with the sending station and greatly increases the steadiness of the pictures. Demonstrations showed that images received by these television sets are of such brilliance that they can be viewed comfortably in daylight or in a normally lighted room. One of the table models to be offered March 10 has a picture area of 23 square inches. The other presents a picture 52 square inches in size.

The former is priced at \$250 in walnut and \$260 in blonde, the latter is \$375 in walnut finish. These prices are exclusive of the company's Television Owner's policy which covers cost of antenna and installation of re-



John Ballantyne (left), president, Philco Corporation, is awarded War Department Certificate of Appreciation by Lt. Col. Arnold T. Gallagher, Commanding Officer, Philadelphia Storage and Issue Agency, Signal Corps.

ceiver and antenna plus a year's service and maintenance of the sets. This policy is offered with the receiver for a flat nominal fee.

Two other television receivers will be introduced to this market later in 1947: a complete home entertainment unit which incorporates a 52 square inch television screen with standard broadcast, FM, and international short wave radio, and automatic phonograph. Another includes 3-band radio reception and presents a television picture 300 square inches in size — almost as large as a newspaper page.

## Jewel Radio S.M.

Don Ferraro, president of the Jewel Radio Corporation, 583 Avenue of the Americas, New York City, announces the appointment of A. Earle Fisher as sales manager. Mr. Fisher was previously employed for a year and a half as West Coast Regional Manager for Emerson Radio.

## Operadio Sales Manager

Appointment of Arch Samuelson as sales manager of the Operadio Manufacturing Company's Commercial Sound Division, is announced by Fred D. Wilson, general sales manager. Mr. Samuelson has been associated with Operadio for several years as Midwest District Manager.

## Joins Clarion Radio

Reau Kemp, sales manager of Clarion Radio announces that C. H. Hunter has joined the organization as divisional sales manager for the South and Southeastern territories. "Hap" as he is known to the trade, has been occupied in appliance merchandising for almost twenty years. Most recently



# Summer Time is "Portable" Time!

AND IT'S TIME TO  
**MAKE EXTRA MONEY**  
 AND GIVE BETTER SERVICE

by Installing **FEDERAL'S** Miniature Selenium Rectifier in AC-DC Portables to replace the rectifier tube



Type 403D2625

More portables are being used this summer than ever before—and you'll have plenty of them coming into your shop for servicing. That's your opportunity to make *extra money*—and satisfied customers too—by installing Federal's Miniature Selenium Rectifier to replace the rectifier tube. For you not only make a *substantial extra profit* on each set—you give *better service*, because this Selenium Rectifier assures faster starting on AC operation—less heating—longer life.

Installation is simple—a few soldered connections, and minimum circuit changes. Though small in size, these money-making Miniature Rectifiers embody the same refinements of design which have made Federal "Center Contact" Selenium Rectifiers the standard of quality throughout the industry.

They are available through major jobbers from coast to coast—complete with instruction books and sales aids.



KEEPING FEDERAL YEARS AHEAD... is IT&T's world-wide research and engineering organization, of which the Federal Telecommunication Laboratories, Nutley, N. J., is a unit.

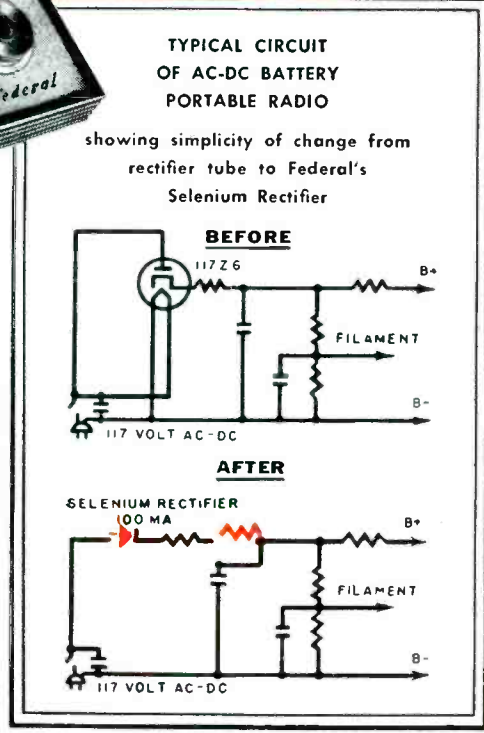

## Federal Telephone and Radio Corporation

SELENIUM and INTELIN DIVISION, 1000 Passaic Ave., East Newark, New Jersey  
 In Canada: — Federal Electric Manufacturing Company, Ltd., Montreal.  
 Export Distributors: — International Standard Electric Corp., 67 Broad St., N. Y. C.

# SILVER

## AM PLUS FM 90 KC-210 MC

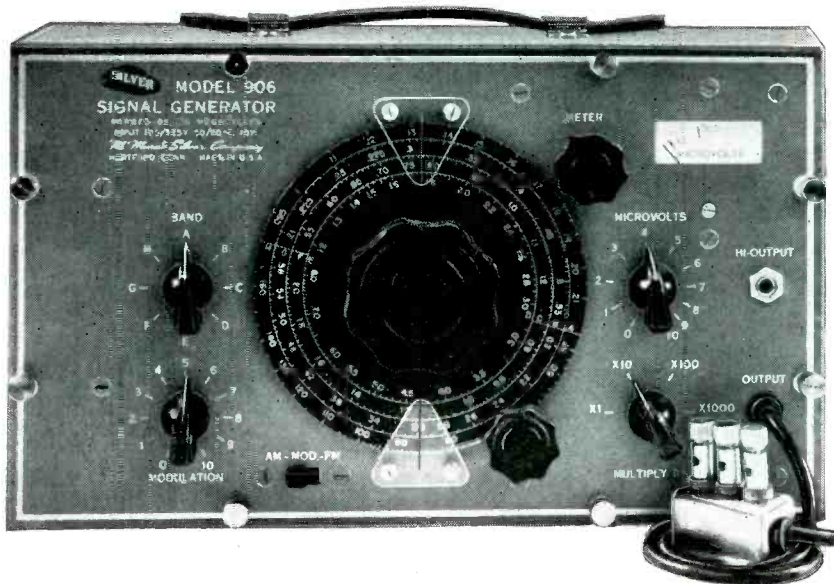

The one word "greatest" best describes new MODEL 906 Signal Generator . . . greatest frequency range of 90 kc. through 170 mc. AM; 90 kc. through 210 mc. FM . . . greatest calibration accuracy of 1% . . . greatest output range — metered and continuously variable from less than 1 microvolt to over 1 volt . . . greatest freedom from strays . . . greatest "buy" in history at only \$89.90 net.

Exactly as the unequalled excellence designed and built into "VOMAX" makes it outstanding the preferred, truly universal v.t.v.m., so SILVER engineering brings you in MODEL 906 a signal generator utterly without equal.

## "VOMAX"

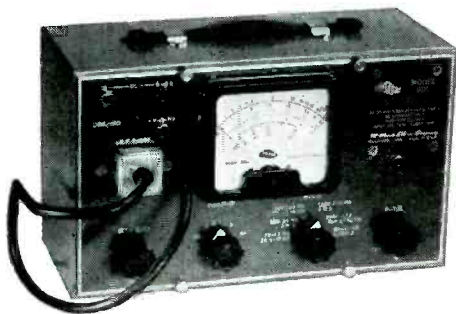

development maintains "VOMAX" as the finest, most complete meter you can buy . . . still for only \$59.85 net. Present "VOMAX" users can get the new flexible pencil probe kit for 35c from their jobber.

## NEW FLEXIBLE PENCIL R. F. PROBE

For two years "VOMAX" has stood head and shoulders above all other meters for a.c., a.f., i.f., r.f. and d.c. voltage range . . . unequalled current and resistance ranges . . . laboratory accuracy . . . high meter input resistance . . . for real value.

Now "VOMAX" is equipped with a new, pencil-thin r.f. probe extension 5" long plus companion grounding clip and lead. With it you can reach any point in the "tightest" midget receiver chassis . . . you can bend the probe around corners if you have to! This exclusive new SILVER

**NEW 16-PAGE CATALOG.** Mail a penny post-card for complete data on these and other new SILVER products . . . famous "SPARX" visual and aural signal tracer, laboratory condenser/resistor tester, new amateur xtal-controlled all-band exciter, 80 thru 6 meter 40-watt pre-tuned frequency multiplier, transmitters, receivers, etc.

OVER 36 YEARS OF RADIO ENGINEERING ACHIEVEMENT

*McMurdo Silver Co., Inc.*

1240 MAIN ST., HARTFORD 3, CONNECTICUT

he was district manager of the central middle-west for Proctor Electric Company, and previous to that manager of the Bendix branch at S. Louis. His background is well suited to the assignment he has taken for Clarion, since, in addition to the connections above, he represented one of the leading radio factories for a period of seven years.

## Operadio Promotes Intercom

Operadio Manufacturing Co., St. Charles, Ill., is releasing a sound slidefilm entitled, "At the Speed of



Top picture shows compact controls; lower cutaway shows details of construction and chassis of the Flexifone intercom control unit.

Light" to all distributors and dealers. It is primarily directed at the consumer, but is also suitable for sales training and dealer meetings. The complete story on Flexifone Intercommunication Equipment is shown in just twelve minutes.

## GE Television Plan

The new General Electric television receiver and dealer appointment program were presented in the Barnum Hotel, Bridgeport, by David H. Fisher, radio sales Manager, General Electric Supply Corporation of Connecticut. Model 801 is a direct view instrument.

The theme of the meeting stressed the necessity for dealers to have adequate service facilities in order to assure complete customer satisfaction. This was described as more important than the dealers' ability to sell a quan-

[see page 34]



**RACONS** do more  
at lower cost than  
ordinary reproducers

**ACOUSTIC & STORMPROOF MATERIAL**

Only RACON makes speakers with Racon Acoustic Cloth which is processed by a patented method giving a non-vibratory wall, thereby increasing the output of the horn without loss due to wall vibration. Supplied as a part of all re-entrant horns, and on all straight horns when so ordered. Stormproof types are guaranteed for life in all kinds of weather and temperature, regardless of climatic conditions.



Straight Trumpet



Dwarf Re-entrant

**ADVANCED ENGINEERING & DESIGN**

RACON'S leadership in sound reproducer engineering has been recognized for almost three decades. RACON driver units have a rated output for peak and continuous performance far in excess of any other brands — continuous operating capacity 30 watts, peak capacity 60 watts. RACON speakers and driving units require less energy input yet they deliver more efficient sound reproduction output. All claims made by RACON as to cutoff frequencies and acoustic lengths of speakers, power handling capacity, efficiency and frequency range of driver units are substantiated by tests made at laboratories recognized as the foremost in the industry.

**COMPLETE LINE TO CHOOSE FROM**

There is a RACON driving unit, trumpet or speaker for every conceivable sound application — also the accessories (brackets and housings) that may be required for special purposes. Soundmen know that it pays to choose and use a speaker line that is complete. Yes — RACON makes every kind of sound reproducer from the giant 7 foot length auditorium horn down to the small 4 inch intercom cone speaker — from the super giant P.M. driving unit to the tiny driver for paging horns.

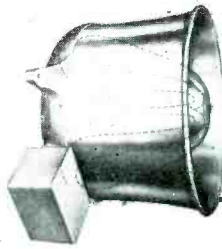

Marine Speaker



P-M Unit

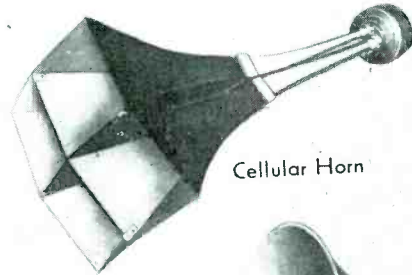

Cellular Horn



Re-entrant Trumpet



High Frequency Speaker

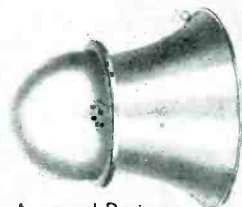

Armored Projector



Paging Horn

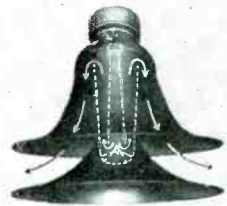

Radial Re-entrant



**RACON**

RACON ELEC. CO., INC., 52 E. 19 ST., NEW YORK, N. Y.

SEND FOR OUR NEW FREE CATALOG

Racon Elec. Co., Inc.  
52 E. 19th St., New York 3, N. Y.

Gentlemen: Please send me a copy of your new free catalog.

Name .....

Address .....

City & State .....



# A SIGN OF SUCCESSFUL SERVICING

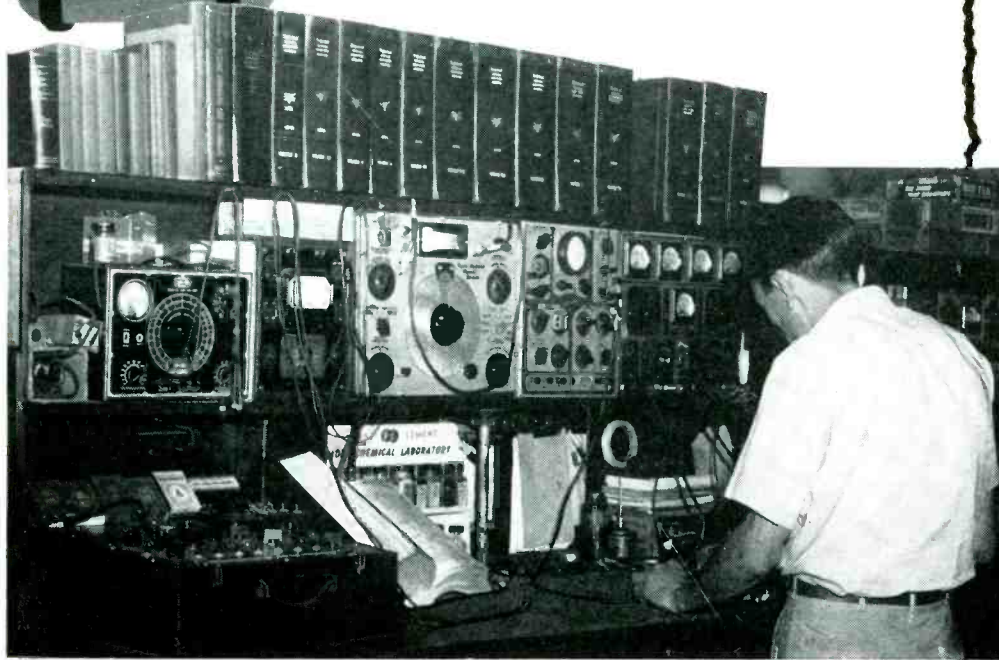

## Couch has all fifteen RIDER MANUALS

W. J. Couch & Company of Tullahoma, Tenn., was recently featured in a national radio publication because of the completeness of its servicing equipment. In the Couch shop, as in thousands of other successful servicing establishments, you'll find all fifteen Rider Manuals in daily use. From no other single source is such data available.

Comprehensive servicing information is essential to shops called upon to service all makes and all types of radio receivers—of all ages. That's why the first fourteen volumes of Rider Manual are so time-savingly valuable to the average shop. These volumes alone cover the years when 82% of the sets now in American homes were issued. (From 1920 to April 1942 inclusive.)

And, the information on these receivers is the OFFICIAL, AUTHORIZED servicing data direct from the service departments of the manufac-

turers who made the sets. No one knows better than the manufacturer what procedures are best for his product. That is the foundation on which Rider Manuals are built.

Volume XV, covering sets issued during 1946, plus some unpublished pre-war models, is the result of "Seventeen Years of Continuing Service to the Radio Servicing Industry". It is full of exclusive features. For example, the 520 "clarified-schematics", which break down composite diagrams of complicated multiband receivers into individual schematics of each circuit as it exists with each turn of wave band or equipment switch.

With each Volume XV is the 200-page "How It Works" book, a guide to the theory of operation of new technical features in latest receivers. Volume XV also has all popular "Ham" communication receivers, Scott receivers, Magnavox RA combinations and record player combinations. These you find only in Rider Publications.

Rider Manuals are an investment which keeps pouring out profits for you. Those who bought Volume I, 17 years ago, are still benefitting from it. Be sure your shop has the Sign of Successful Servicing—all fifteen Rider Manuals.



### VOL. XV JUST OUT!

2000 pages, plus  
200 page "How  
It Works" Book.  
\$18.00 complete

Volumes XIV to VII (each volume).....	\$15.00
Volume VI .....	11.00
Abridged Manuals I to V (one volume).....	17.50
Record Changers and Recorders .....	9.00

## RIDER MANUALS MEAN SUCCESSFUL SERVICING

SEND IN YOUR ENTRY  
NOW!

There are  
224  
Opportunities  
to WIN

## RIDER MANUAL CONTEST

\$4,325.<sup>00</sup>  
WORTH OF

## CASH PRIZES

AND  
SERVICING  
EQUIPMENT

JUST TELL WHY  
(in 100 Words or Less)

### "RIDER MANUALS MEAN SUCCESSFUL SERVICING"

That's all you need do. Nothing to buy. Nothing difficult. No need for fancy writing. Write your entry on official blank, obtainable from your parts jobber, in plain everyday English. The first thing you write may win you one of the 224 valuable prizes. Call your jobber.

GET THE OFFICIAL  
ENTRY BLANK  
FROM YOUR JOBBER  
TODAY!

JOHN F. RIDER  
Publisher, Inc.

404-4th AVE., N. Y. 17, N. Y.

Export Division,  
Rocke International Corp.,  
13 E. 40th St., New York City  
Cable ARLAB

# Now...

**New BATTERY OPERATED  
RCA VOLTOHMYST**

## you can use it anywhere!

**Measures voltage  
resistance . . . and current**

**A**BOUT THE HANDIEST METER in the service field! In one instrument, for one price, you get an electronic voltmeter, ohmmeter, and ammeter . . . *battery-operated* to make it completely independent of power-line sources.

Use it to test car radios, farm sets, railroad signal equipment, aircraft radio, industrial electronic devices . . . opens up hundreds of profitable new opportunities beyond the limits of power lines.

With it you can measure both a-c and d-c voltages to 1000 volts, resistance to 1000 megohms, and direct current to 10 amperes. A new low-cost, RCA crystal probe can be attached if you want to make v-h-f measurements.

Most important, this instrument is easy on batteries. They last up to 10 months in normal service. A neon pilot light flashes when the instrument is on . . . serves as a reminder to turn the instrument off when not in use.

Linearity and stability are excellent.

Here is one of the best buys in test equipment on the market today. We'll be glad to send you complete descriptive and price information on this time and money saver. See it at your RCA Test Equipment Distributor.



**TEST AND MEASURING EQUIPMENT  
RADIO CORPORATION of AMERICA  
ENGINEERING PRODUCTS DEPARTMENT, CAMDEN, N. J.**

In Canada: RCA VICTOR Company Limited, Montreal

# TELEVISION QUIZ

If you believe you now have sufficient technical knowledge and ability to install and service television receivers - - here is a SELF-TEST that will quickly and accurately confirm or refute your opinion.

Every question in this examination is fundamental and basic. Any radio technician who expects to engage in servicing or installing television receivers should be able to pass this quiz, or one of comparable intensity, with a mark exceeding 80% even though the N. Y. Board of Education rates 65% as a "passing grade".

Try this quiz on yourself. Have your associates (technicians only) do likewise. It is educational and provides fun, too. If you want us to publish more quizzes like this, on FM and other relatively new phases of radio, let us know. *Editor.*

## HERE ARE THE QUESTIONS:

Before starting the quiz, read the text in the box on the top of the next page. Also carefully read the "Rules" outlined there. Allow 50 minutes maximum for the quiz. Unanswered questions must be scored as having been answered incorrectly. Check your watch — GO!

### QUESTIONS 1 to 10

1. Television waves are: —  
a. Reflected from the ionosphere  
b. Quasi optical  
c. Refracted from the ionosphere
2. A reflector-director type of antenna has a characteristic impedance of approximately — ohms.  
a. 300      b. 100      c. 20
3. A television antenna erected at the receiver should — the transmitter.  
a. be pointed towards  
b. face broadside to  
c. be directed at an angle of 45°
4. In order to match a 300 ohm antenna to a 72 ohm transformer the quarter wave matching section should be — ohms.  
a. 300      b. 150      c. 72
5. A folded dipole has a characteristic impedance of — ohms.  
a. 300      b. 150      c. 72
6. A half-wave dipole antenna has a characteristic impedance of — ohms.  
a. 72      b. 150      c. 300
7. A half-wave six meter dipole antenna is approximately — feet long.  
a. 6      b. 12      c. 9
8. The typical television dipole antenna is a — antenna.  
a. full-wave      b. half-wave  
c. quarter-wave
9. Waves are no longer reflected from the ionosphere at — M.C.  
a. 10      b. 20      c. 60

10. Maximum television distance coverage between a transmitter antenna 900 feet high and a receiving antenna 100 feet high is — miles.  
a. 5      b. 50      c. 500

### QUESTIONS 11 to 20

11. A ghost image separated from the original image by  $\frac{1}{8}$ " on a television screen represents reflections from an object — away.  
a. 100 ft.      b. 1000 ft.      c. 5000 ft.
12. Transmission line resistance is usually expressed by the following term: —  
a. Impedance      b. Resistance  
c. Characteristic Impedance
13. The typical television antenna is a: —  
a. vertical dipole  
b. horizontal dipole  
c. vertical marconi
14. A dipole placed on one side of a director favors reception from a direction: —  
a. on the side of the director  
b. on the side of the dipole  
c. from the ends of the dipole
15. The photo-sensitive material on a mosaic is: —  
a. thorium      b. graphite  
c. caesium silver
16. A camera tube is usually called a: —  
a. kinescope      b. iconoscope  
c. oscilloscope

17. Present day television standards utilize — transmission.  
a. 525 lines      b. 441 lines      c. 60 lines
18. Interlaced scanning is the process whereby each line is: —  
a. interlaced with the next line  
b. followed by the next line  
c. scanned alternately
19. The frame frequency is — cycles per second.  
a. 30      b. 60      c. 15,750
20. The field frequency is — cycles per second.  
a. 30      b. 60      c. 15.750

### QUESTIONS 21 to 30

21. Blanking takes place during —  
a. the time in which the synch pulses occur  
b. the signal period  
c. the time the transmitter carrier is zero
22. — transmission is used in Europe.  
a. negative      b. positive      c. neutral
23. — transmission is used in this country.  
a. negative      b. positive      c. neutral
24. During the retrace period the picture tube is: —  
a. disconnected from the circuit  
b. blanked out  
c. all white

These are the actual Questions & Answers that were used recently in the "Examination of Radio Teachers In-Service Course" by the New York Board of Education

**BEFORE ANSWERING THE QUESTIONS—READ THESE RULES:**

There are 50 questions. After each question, preceded by a letter *a*, *b* or *c* are optional answers. But in each case only one of the answers is correct. You are only allowed 50 minutes time in which to mark the letter *a*, *b* or *c* which you believe represents the correct answer. For each correct answer to

a question you are credited with 2 percentage points. Thus 47 correct answers would give you 94% or 36 correct answers would rate you 72% on the examination. Answers to the questions are given on Page 33.

**RATINGS FOLLOW:**

100% = Perfect, 90% = Excellent, 80% = Good, 70% = Fair, 60% = Passing  
Any score below 65% is failure. Tests must be completed within 50 minutes.

25. The \_\_\_\_\_ controls the timing of the vertical and horizontal pulse generators in the transmitter.

- a. timing unit
- b. horizontal signal generator
- c. vertical signal generator

26. The exact wave shape of the signal is developed in the: \_\_\_\_\_

- a. Timing unit
- b. shaping unit
- c. keying unit

27. The different signals in a transmitter are locked into position in the final signal by the: \_\_\_\_\_

- a. Timing unit
- b. shaping unit
- c. keying unit

28. The D-C component changes: \_\_\_\_\_

- a. the video reference level with respect to the black level
- b. the amplitude of the synch level
- c. the amplitude of the white level

29. The synchronizing pulses: \_\_\_\_\_

- a. trigger the horizontal and vertical generators simultaneously.
- b. control the amplitude of the pulses.
- c. start the vertical and horizontal scanning generators in the transmitter and receiver at the same respective times.

30. Negative transmission is the type in which: \_\_\_\_\_

- a. The transmitted energy is in the negative half of the cycle.
- b. The amplitude of the signal varies directly with the amount of light televisualized.
- c. The amplitude of the signal varies inversely with the amount of light televisualized.

**QUESTIONS 31 to 40**

31. The video signal in the camera tube is developed: \_\_\_\_\_

- a. in the mosaic.
- b. On the collector anode.
- c. Across the load resistor connected between the collector anode and the mosaic.

32. The collector anode receives its electrons from: \_\_\_\_\_

- a. the mosaic.
- b. the second accelerating anode.
- c. the deflecting plates.

33. The purpose of the electron gun is to: \_\_\_\_\_

- a. direct a stream of electrons towards the collector plate.
- b. direct a stream of electrons towards the mosaic.
- c. direct a stream of electrons towards the deflecting plate.

34. Wide band-pass in television is obtained by: \_\_\_\_\_

- a. band-pass filters.
- b. overcoupled transformers.
- c. high L/C ratio resonant circuits.

35. The mosaic in an iconoscope camera tube: \_\_\_\_\_

- a. emits secondary emission electrons from its light struck areas when bombarded by electrons from the electron gun.
- b. stores electrons when light strikes it.
- c. emits secondary emission electrons from its dark areas when bombarded by electrons from the electron gun.

36. The purpose of the R-F stage in a television receiver is to: \_\_\_\_\_

- a. increase the gain substantially.
- b. improve image frequency rejection.
- c. provide wide-band response.

37. The gain of an R-F stage in a television receiver is approximately: \_\_\_\_\_

- a. 1
- b. 10
- c. 100

38. The R-F tuning circuit is aligned for maximum response at: \_\_\_\_\_

- a. the audio carrier
- b. the video carrier
- c. in the middle of the band

39. The purpose of the oscillator vernier tuner is to: \_\_\_\_\_

- a. compensate for oscillator frequency drift
- b. adjust the oscillator at the low frequency end of the band
- c. adjust the oscillator at the high frequency end of the band

40. The frequency difference between the video carrier and the audio carrier is: \_\_\_\_\_

- a. 8.25 M.C.
- b. 4.5 M.C.
- c. 12.75 M. C.

**QUESTIONS 41 to 50**

41. The I.F. sound rejector circuit is tuned to: \_\_\_\_\_

- a. 8.25 M.C.
- b. 150 K.C.
- c. 12.75 M. C.

42. In vestigial side-band transmission the \_\_\_\_\_ side band frequencies are eliminated.

- a. lower
- b. higher
- c. middle

43. The broadcast television signal contains twice as much energy at the \_\_\_\_\_ modulating frequencies.

- a. lower
- b. higher
- c. middle

44. In order to compensate for the unequal energy values contained in the transmitted television signal at the various modulating frequencies the receiver I-F response characteristic is adjusted to 50% of the maximum at: \_\_\_\_\_

- a. the audio carrier
- b. video carrier
- c. middle of the band

45. The video R.F. is \_\_\_\_\_ in frequency than the audio R.F.

- a. higher.
- b. lower
- c. neither higher nor lower

46. The video I.F. is \_\_\_\_\_ in frequency than the audio I.F.

- a. higher
- b. lower
- c. neither higher nor lower

47. A.V.C. circuits used in sound broadcast receivers cannot be used in television receivers because: \_\_\_\_\_

- a. the amplitude of the average carrier varies.
- b. negative transmission is employed.
- c. positive transmission is employed.

48. A parallel resistor across a tuned circuit \_\_\_\_\_ the band-pass.

- a. broadens
- b. sharpens
- c. neither broadens nor sharpens

49. A parallel resistor across a tuned circuit \_\_\_\_\_ the band-pass.

- a. increases
- b. reduces
- c. neither reduces nor increases.

50. Peaking coils are used in \_\_\_\_\_ circuits.

- a. I.F. circuits
- b. R.F. circuits
- c. Video amplifier circuits

**T**HE present carrier frequency band assigned to FM extends from 88 to 106 megacycles. The 106 to 108 megacycle range is set aside for facsimile and is not in general use at this time. *Figure 1* shows the spectrum location of the new VHF FM and facsimile bands with respect to the standard broadcast and short wave band. The prewar FM band, (41 to 44 mc), also is shown in the spectrum chart for comparison purposes. The dial scale shown in this illustration is that of the Westinghouse Model H-119 AM-FM receiver, which is to be discussed later in this article.

*Figure 2* shows, at this very-high-frequency range, how propagation of radio waves follow more or less optical laws as compared with the standard broadcast range from 540 to 1600 kilocycles used in AM systems. Briefly, this means that the radio waves act somewhat like light waves and "line-of-sight" wave propagation plays an important part. Under ideal conditions the terrain between the transmitting and receiving antennas should have no continuous obstructions such as large buildings, hills, etc. In actual practice ideal conditions are seldom realized. Frequently, very good FM reception may be obtained under conditions which according to the "line-of-sight" theory would make reception impossible. However, in general, the VHF wave propagation theories are true and a good understanding of the characteristics of the new frequencies will be helpful, particularly in the "tough" locations remote from the FM transmitters.

According to the accepted theory, the electric field intensity of the FM wave varies inversely with the *square* of the distance from the transmitting antenna to the receiver. For production of a *true frequency modulated* signal to be passed on to the discriminator in the receiver, a good husky signal at the limiter grid is an absolute necessity. Unless there is a signal of sufficient strength to saturate the limiter, amplitude signals will be passed on to the discriminator, resulting in very poor tone quality and distorted output. This requirement practically dictates the use of a good, well-elevated outside antenna.

### FM ANTENNA FUNDAMENTALS

The design of a suitable antenna for receiving FM waves might seem a very simple problem. Actually, however, a number of factors are involved. Let us examine these factors from the practical design standpoint.

\*The basic parts of this series are published by courtesy of Westinghouse Elec. Corp. Home Receiver Div. whose brochure "Radio Service School" is a course in itself on FM.

# FREQUENCY

**Frequency Modulation is just coming into stride. Here, in part I of a series, we cover FM antenna fundamentals and signal shifting effects.\***

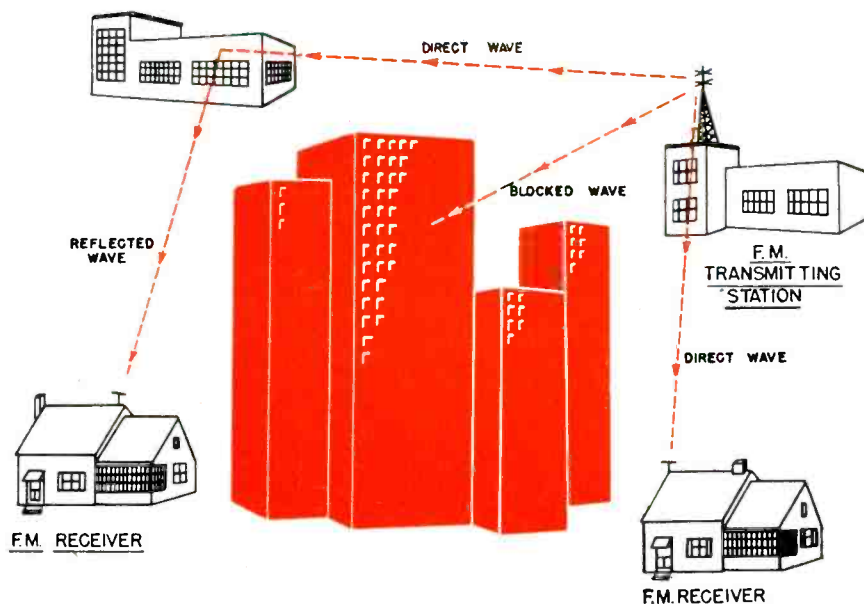

The antenna input impedance determines the value of the r-f voltage developed across the dipole gap (load impedance) inasmuch as the voltage developed is determined by the values of the current flowing and the load impedance at that particular instant. It may be expressed mathematically by Ohm's law for alternating current:

$$E = IZ$$

where E and I are the r-f voltages and currents, respectively, and Z is the impedance at the center of the dipole at any given instant. The impedance may be expressed as

$$Z = \sqrt{R^2 + X^2}$$

where R and X are the antenna input resistance and reactance, respectively.

In a half-wave antenna, *resonant to a fixed frequency*, the current is a maximum at the center and zero at the ends, while the voltage is a maximum at the ends and a minimum at the center. For this half-wave *resonant* dipole, then, the impedance varies along the antenna and is minimum at the center and maximum at the ends. For a half-wave dipole, *resonant and isolated in free space*, the impedance

at the center is approximately 73 ohms and approximately 2500 ohms at the ends. The intermediate points between the center and each end have intermediate values of impedance. The 73 ohms impedance at the center represents the vector magnitude of the effective resistance and a small residual reactance; however, for all practical purposes it may be considered a pure resistance. For *single, fixed frequency operation*, then, the transmission line should present a characteristic impedance to the center of the dipole, equal to the dipole center impedance, or, in other words, the characteristic impedance of the transmission line should be 73 ohms. But wait! Don't jump to any conclusions! We are now talking about a half-wave antenna resonant to a single frequency. For FM we have entirely different conditions.

### SIGNAL SHIFTING EFFECTS

The FM signal is constantly shifting in frequency with applied modulation. So far as the impedance value is concerned, the effect is exactly the same

# MODULATION

## PART I

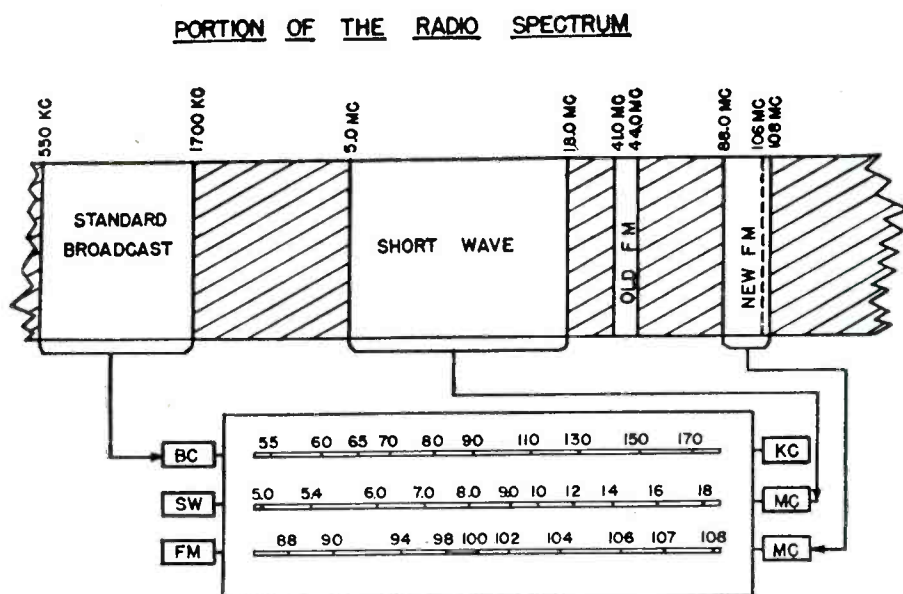

Figure 1—The spectrum location of the new VHF-FM bands and relative band positions on Westinghouse Model 119 AM-FM Receiver

as would be encountered if the frequency were fixed and the length of the dipole were varied. At frequencies higher than the resonant frequency of the antenna, the dipole acts as inductive reactance and at frequencies lower than its resonant frequency it acts as a capacitive reactance. Remember that the center impedance value is equal to the square root of the sum of the squares of the resistance and the reactance. In short, as the signal frequency swings back and forth across resonance, the impedance value "travels" up and down its scale of values for the single FM signal. Furthermore, we are not interested in receiving *only one* FM station—we wish to receive stations all the way across the FM band. Most ideas for leveling out the extreme impedance values encountered at the band edges are too costly for anything other than certain commercial applications. For ordinary FM reception, a good compromise can be effected by making the dipole elements

large in diameter, overlapping them slightly at the center and selecting the correct resonant frequency length.

### DETERMINATION OF FM ANTENNA LENGTH

If reception of programs from only *one* FM station is desired, the dipole elements would be cut to a half-wave length at the center or unmodulated carrier frequency according to the formula:

$$\text{Length of half-wave (inches)} = \frac{5540}{\text{Freq. (mc)}}$$

In a practical installation, however, reception of more than one FM station is desired. Thus the length of the elements must be cut to some intermediate frequency which will give a satisfactory response at the extreme ends of the band and yet keep the standing wave ratio (mis-match) of the transmission line between the dipole and the receiver input, to the minimum. In general, the frequency to which a broadly resonant antenna is

cut, is equal to the geometric mean of the frequency extremes of the band to be covered. For the 88-106 megacycle band, the frequency at which the antenna should equal one half-wave is:

$$\text{Frequency in MC} = \sqrt{88 \times 106} = 97 \text{ mc.}$$

The actual length of the elements, in inches, according to the above formula, is:

$$\text{Length} = \frac{5540}{97} = 57.1 \text{ inches}$$

Like most other practical applications of electrical theory, however, it is necessary to modify the actual element length for maximum efficiency across the FM band. In order to obtain a semi-broad-band characteristic in the Westinghouse Stratovision FM antenna, the two elements overlap at the center insulator. It was found necessary to increase the overall dipole length, end to end, to 62 inches to compensate for this physical characteristic.

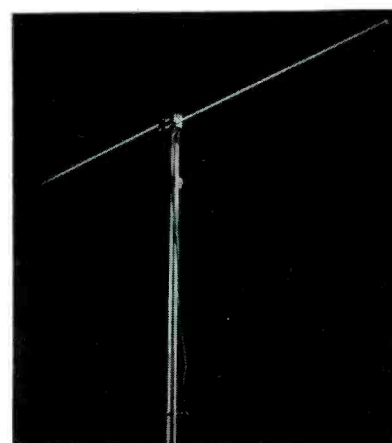

Figure 3—Note how the elements of the dipole overlap at center in Westinghouse Stratovision antenna

### FM TRANSMISSION LINE IMPEDANCE

As mentioned above, the impedance at the center of an FM receiving dipole antenna cannot be stated as any given value. In actual practice it varies anywhere from 68 ohms to 1000 or 1500 ohms, depending upon the length and diameter of the dipole elements and the portion of the FM band to which the receiver is tuned. It is obvious that no fixed value of transmission line impedance can be selected and matched to the center of the antenna. It is necessary to select some "happy medium" value which will operate most efficiently over the entire FM band. Due to the rather high standing wave ratios encountered at the band extremes, the transmission

[see page 32]

# Automatic Gain Control

The Automatic Gain Control circuits of commercial television receivers vary considerably. This article analyzes the circuits most likely to be encountered in present-day work

by S. L. MARSHALL

**A**UTOMATIC gain control (A.G.C.) is comparable to automatic volume control (A.V.C.) insofar as it maintains the amplitude of the incoming signal at a constant level. A fading audio modulated carrier in a receiver without A.V.C. results in a reduction in volume. A fading television signal in a receiver without A.G.C. results in an unstable picture. This is because the amplitude of the synchronizing pulses at which the picture tube has been adjusted is no longer maintained by the incoming signal.

## REVIEW OF A.V.C. ACTION

For purposes of comparison, the method of obtaining A.V.C. in audio modulated transmitters and receivers will be briefly reviewed. The waveform of a transmitted signal showing the relative amplitudes and positions

of the audio and r-f carrier components of a typical broadcast signal is shown in Fig. 1.

A typical high-level plate-modulated transmitter output stage and its developed amplitude-modulated waveform is illustrated in Fig. 2. Since the carrier voltage is in series with the audio voltage, the amplitudes of both signals are additive. This applies to the negative as well as the positive values. Therefore, waveshape (a) added to waveshape (b) produces waveshape (c).

During the process of demodulation, or detection, in which a typical circuit such as the one shown in Fig. 3 is used, the action is as follows:

The modulated carrier is impressed on the diode rectifier so that a rectified modulated carrier, which is a pulsating D.C., appears across the load resistor  $R_1$ . See Fig. 3b. The time-constant of  $R_2$  and  $C_1$  is such that the

audio variations are no longer effective and only the average value of the rectified signal appears at point B. This is always equal to the amplitude of the carrier irrespective of the audio modulating components. For this reason the d-c component developed at point B depends only on the strength of the unmodulated carrier.

## TELEVISION CARRIER WAVEFORM

Consider now a typical television transmitter output circuit, shown in Fig. 4. Observe that the video modulating impedance,  $L_1$  and  $R_1$ , is the source of grid bias for the power output stage. The grids of this stage are biased by the voltage drop across this impedance, which is also the plate load impedance of the modulating tube. This bias is adjusted so that with no

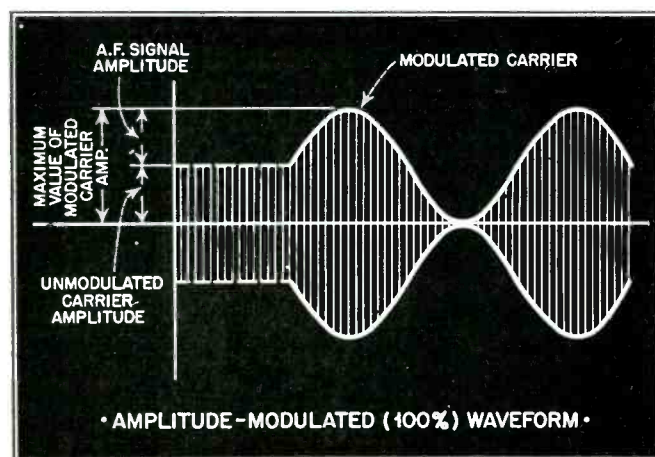

Figure 1

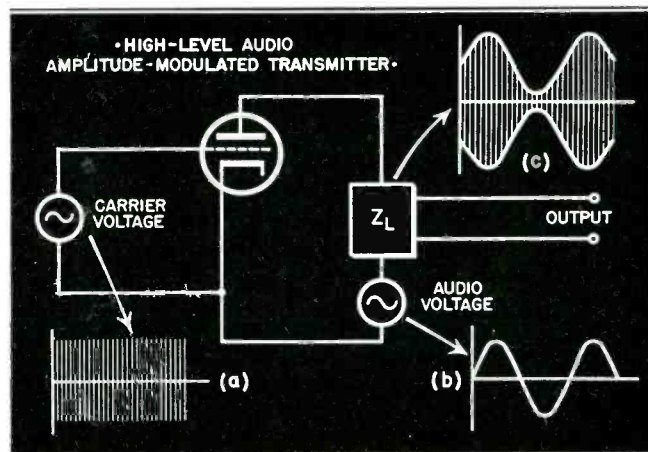

Figure 2



# Circuits in Television Sets

signal at the grid of the modulating tube the maximum R.F. power is developed in the output circuit. Let us assume that this condition obtains between points 1-2 in Fig. 4d.

Suppose now that the video signal is applied at the input terminals. Ordinarily the polarity of the synchronizing peaks (black level) is positive, as shown in Fig. 4a. At this point in the transmitter a suitable circuit arrangement inverts this relationship and the white level is made positive with respect to the synch peaks. See Fig. 4b. As a result, the bias on the modulating tube is not changed by the synch pulses since the amplitude of these pulses at this point is almost zero, whereas an increase in white level makes the grid more positive. The corresponding plate voltage on the modulating tube increases in a negative direction as the white level increases.

This same voltage is directly applied to the grids of the power tubes. For this reason the synch pulses of the video signal produce no change in the "C" bias on the power tubes and no change in the power output of the composite carrier. On the other hand, as the video signal approaches the white level the "C" bias on the power tubes is increased, and the total power output of the carrier is reduced. Thus, for an absolute white picture element the power output is practically zero. This is shown in the interval 3-4 in Fig. 4d. In this manner the synch pulses are maintained at a constant amplitude corresponding to the amplitude of the unmodulated carrier.

The conclusion arrived at from this analysis is that the average video carrier cannot be used as a reference level for A.G.C. since it changes constantly with the video signals. However, the amplitude of the synch pulses is constant, and for this reason it may be used as a reference level for A-G-C purposes.

## VIEWTONE MODEL VP 101A

A-G-C circuits vary considerably in various commercial television receivers. A rather simple circuit is used in the Viewtone Model VP101A. This is shown in heavy lines in the sim-

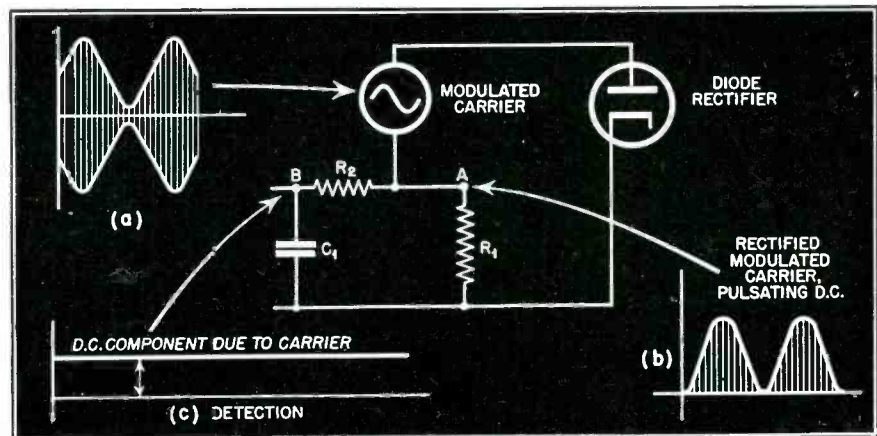

Figure 3

plified diagram illustrated in Fig. 5.

The initial point of development of this voltage is at point (A) where a portion of the i-f signal is fed into diode, D<sub>1</sub>, of the dual-diode 7A6 tube, via the coupling capacitor C<sub>1</sub>. An incoming signal will develop a diode current across R<sub>1</sub> and R<sub>2</sub>. The direction of the rectified signal appearing across R<sub>2</sub> makes the polarity of point (B) negative with respect to ground.

The a-g-c filter consists of C<sub>2</sub> and R<sub>3</sub>. All frequencies down to the lowest video modulating frequency will be

almost completely by-passed by C<sub>2</sub>. Furthermore the amplitude of the peaks, corresponding to the synchronizing pulses, determines the a-g-c voltage on the control grid of the 6AC7 converter tube.

Observe that in this circuit, the a-g-c voltage is applied only to the converter. In the other receivers to be described this control voltage is applied also to one or more of the video i-f and r-f stages. It should also be noted that in this receiver the time constant of C<sub>2</sub> and R<sub>3</sub> which is rela-

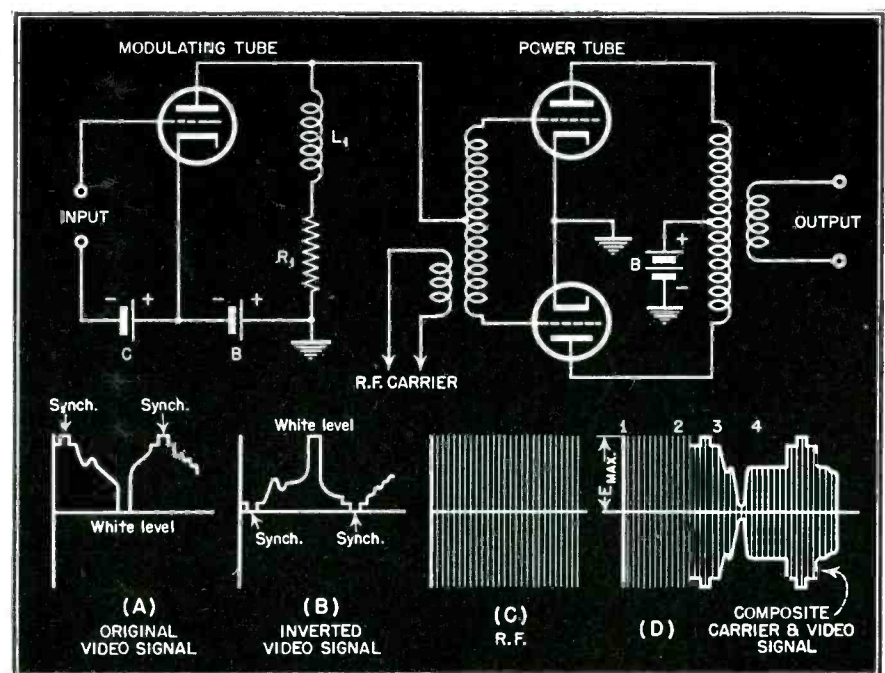

Figure 4

tively long compared to the duration of a synch pulse, is obtained by using almost identical values of resistance and capacitance employed in sound amplitude-modulated a-v-c circuits. A somewhat different ratio of R and C is found in other television receivers. The reasons for this will be discussed when these receivers are analyzed.

### R.C.A.—MODELS T.R.K. 9 AND T.R.K. 12

The a-g-c circuit of the TRK 9 and TRK 12 is shown in Fig. 6. In this diagram the signal is converted into a peak pulse by the a-g-c rectifier, and amplified by a d-c amplifier stage. The a-g-c voltage for the video i-f and r-f stages is derived from the voltage drop across the plate load resistor,  $R_2$ , in the final a-g-c stage.

The signal that gives rise to this voltage appears first at point A, from the last video i-f stage. The second detector diode circuit consists of the full-wave video i-f transformer secondary  $L_1$ , the contrast control across which most of the rectified signal is developed, and the peaking coil circuit,  $L_2$ - $R_5$ . The rectified signal appearing at point, B, is directly coupled into the following stage which is made up of one half of the 6F8G.

The terminal voltages of this tube are such that it is essentially a peak rectifying device, and responds only to the synchronizing pulse components of the signal. The 1 mfd. condenser,  $C_2$ , in the cathode circuit of this tube maintains the amplitude of these rectified pulses at a constant value, so that the voltage appearing at point, C, due to the signal, is essentially d.c. and proportional to the peak values of the incoming signal.

We now proceed to amplify this d-c voltage by means of a d-c amplifier stage consisting of the second half of the 6F8G tube and its associated resistors and condensers. It will be observed that the grid of this tube is returned to -23 volts, and the cathode to -33 volts. This makes the grid -10 volts with respect to the cathode, and, for zero signal, effectively biases the grid to cutoff. For this reason no a-g-c action takes place until the signal voltage is high enough to overcome this initial bias. Thus, a certain amount of delayed A.G.C. is obtained.

The plate load resistance,  $R_2$ , of this tube is returned to a point, -2 volts, with respect to ground. Since this tube is at cutoff during conditions of no signal input, no voltage appears initially at point, E, until a substantial signal occurs. The plate current that results due to this signal makes point, E, of the plate load resistance, negative with respect to its lower end. This voltage is then applied to the video i-f

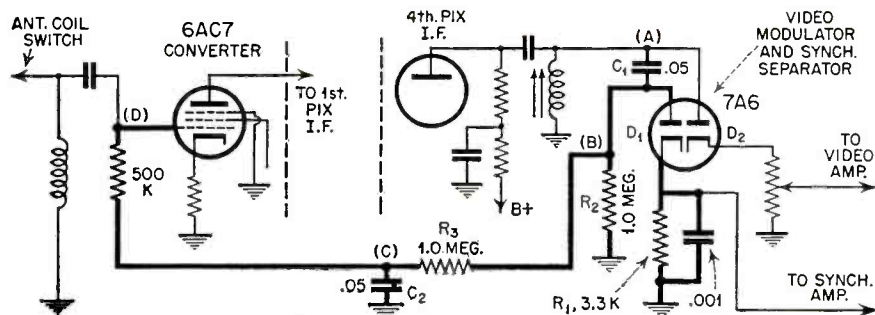

Figure 5

and r-f stages through the a-g-c filter,  $R_1$  and  $C_1$ .

Observe that the values of the a-g-c filter in this circuit are .5 mfd. for the capacitor, and 220,000 ohms for the resistor. Although the time constant for this combination,  $t = RC$ , is essentially equal to the time constant of a .05 mfd-2 meg resistor combination, greater filter effectiveness is obtained by using a higher value of capacitor. This is important in video circuits because a substantial part of the synch pulses on which A.G.C. depends occurs at frame frequency—30 cycles per second.

### GE-HM 225B and HM 226B

A simplified version of the a-g-c circuit of the G.E. #HM 225B and #HM 226B receivers is shown in Fig. 7. One diode of the 6H6-2nd detector is utilized as the video detector, and the other as the a-g-c rectifier. The unconventional arrangement shown in this figure is primarily due to the last video i-f transformer being connected to the cathode of the 6H6 rather than the plate. However, it really makes no difference, in a series rectifier circuit, which side of the tube is connected to the source of A.C.

Observe that the contrast control position varies the relative negative amplitude of the a-g-c plate with respect to the cathode, so that some measure of delay takes place before

the a-g-c voltage action takes place. The diode load resistor,  $R_1$ , across which most of the a-g-c voltage is developed is connected so that, when a signal of sufficient amplitude to cause diode current is present, the diode plate end of the resistor becomes more negative with respect to ground. The

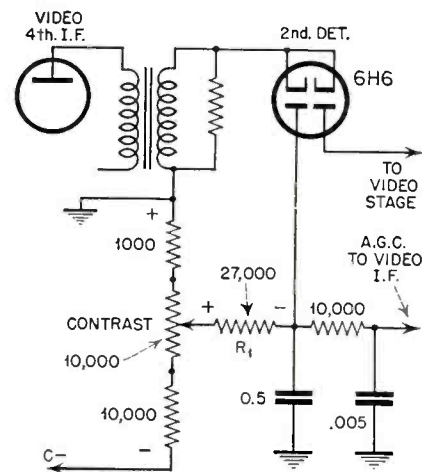

Figure 7

high side of the a-g-c filter is connected at this negative point.

A.G.C. is commanding increasing attention from television receiver designers because of its action in maintaining the signal level constant. The newer models contain circuits which are comparatively elaborate with their predecessors. These will be discussed in a subsequent article.

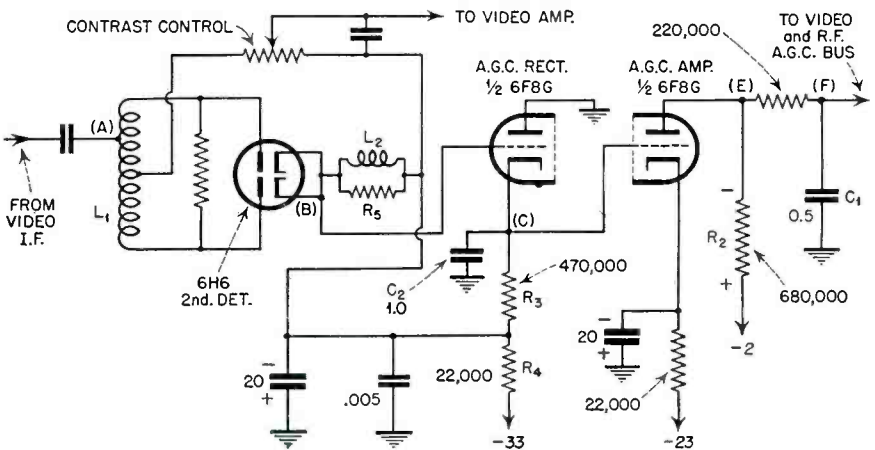

Figure 6

# SYLVANIA NEWS

## RADIO SERVICE EDITION

JULY

Prepared by SYLVANIA ELECTRIC PRODUCTS INC., Emporium, Pa.

1947

# SYLVANIA PRESENTS: Personal Business Forms and Stationery for Time- and Money-Saving EFFICIENCY!

The special business forms shown on this page are items essential to a carefully planned, systematic radio service shop. Sylvania's aim in the prepa-

ration of this material was simply this: to offer radio servicemen the advantages of these time- and money-saving helps at the lowest possible cost.

Efficient Business Record Book—simplified for accurate daily records and tax information. Only \$1.00.

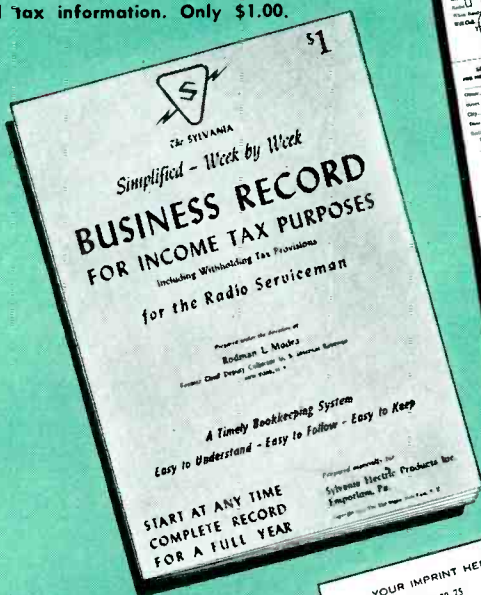

Personal Cards—essential to all businessmen (with your imprint): 250—\$.75; 500—\$1.00.



Job Record Cards (with your imprint)—customer's record and receipt for cash payment; and a complete job record for your files. 100—\$1.00; 250—\$1.75; 500—\$3.00.

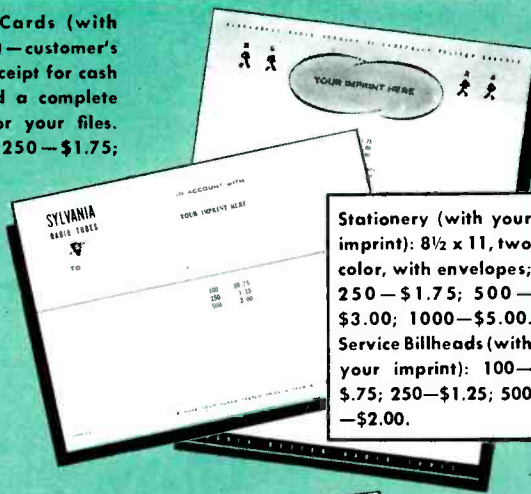
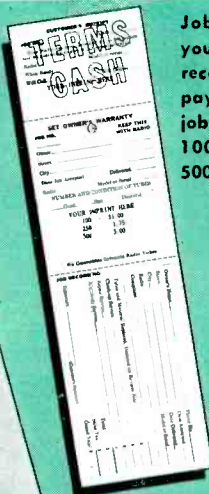

Stationery (with your imprint): 8½ x 11, two color, with envelopes; 250—\$1.75; 500—\$3.00; 1000—\$5.00. Service Billheads (with your imprint): 100—\$.75; 250—\$1.25; 500—\$2.00.

Three-In-One Service Form (with your imprint): Complete job record for your files; customer's invoice and guarantee, and follow-up cards; all in one handy form, perforated for easy use. 100—\$1.50; 250—\$2.50; 500—\$4.00.

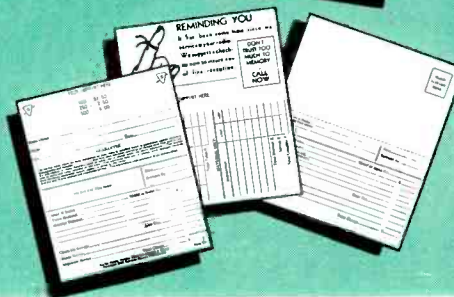

Now is the time to stock up. While you're using these neat, impressive forms and stationery on the home front, Sylvania's extensive advertising—in Life, Collier's, Saturday Evening

Post—is boosting you, your products and your service from coast to coast! To profit from this national sales campaign, use the tested personal sales aids shown.

Order from Sylvania Distributors or write Sylvania Electric Products Inc., Emporium, Pa.

# SYLVANIA ELECTRIC

MAKERS OF RADIO TUBES; CATHODE RAY TUBES; ELECTRONIC DEVICES; FLUORESCENT LAMPS; FIXTURES; WIRING DEVICES; ELECTRIC LIGHT BULBS

# Using A Conventional Signal Generator for FM Alignment

**B**EFORE attempting to align an FM receiver the technician should be familiar with certain facts related to its transmission and reception. Those pertaining to general FM transmission are:

1. The broadcast frequency spectrum lies between 88-106 mc.
2. The frequency deviation of the carrier is linearly proportional to the amplitude of the audio component, varying between 0 to 75 kc. for corresponding percentages of modulation between 0 and 100%. This is shown graphically in Fig. 1.
3. The rate at which the carrier deviates back and forth from its central frequency depends on the frequency of the audio signal. Thus, if the carrier deviates from its central frequency 400 times per second the corresponding audio signal has a frequency of 400 cycles per second.
4. The amplitude of the carrier is constant irrespective of frequency or amplitude of the audio modulating signal. This is in contrast with a conventional amplitude modulated signal in which the amplitude of the carrier is affected by the amplitude of the audio signal, and the rate at which the amplitude of the carrier varies depends on the frequency of the audio signal.

The FM receiver is invariably a superheterodyne containing the conventional r-f, oscillator, i-f, second detector, and audio stage or stages. However, certain circuit features are contained in the receiver which are designed to eliminate noise and static, and to enable the reconversion of the FM signal into an audio signal. The receiver characteristics are as follows:

1. The r-f and i-f transformers must be capable of amplifying without attenuation frequencies that are 100 kc on either side of the resonant frequency of the carrier. This is generally accomplished by using overcoupled tuned circuits, loading resistors connected in parallel with tuned circuits, or both. See Fig. 2.

2. A special circuit is included to remove all amplitude modulated signals. These signals are usually the result of static, both man-made and natural. This circuit is called a *Limit*er, and does exactly what the name

Although sweep frequency signal generators are probably most adaptable for aligning FM receivers, this article describes how less costly conventional type signal generators can also be used for such alignment work

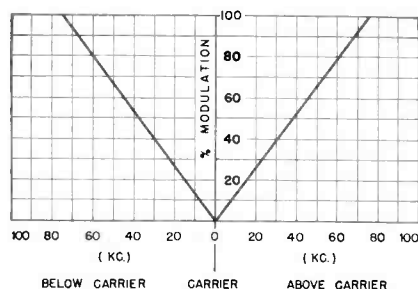

Figure 1

implies; that is, it prevents signals of amplitude limits over a certain predetermined value from entering the second detector. Since the FM signal itself has a constant amplitude it is not affected by the limiter. On the other hand, static and noise, which are generally characterized by pulses of short duration and high amplitude are effectively reduced by the action of the limiter. Fig. 3 shows graphically the action of the limiter in clipping high amplitude pulses.

3. The second detector stage follow-

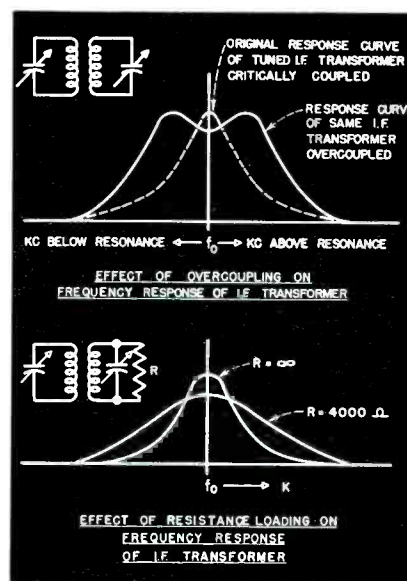

Figure 2

ing the limiter contains a special circuit, the function of which is to convert the frequency deviations into ampli-

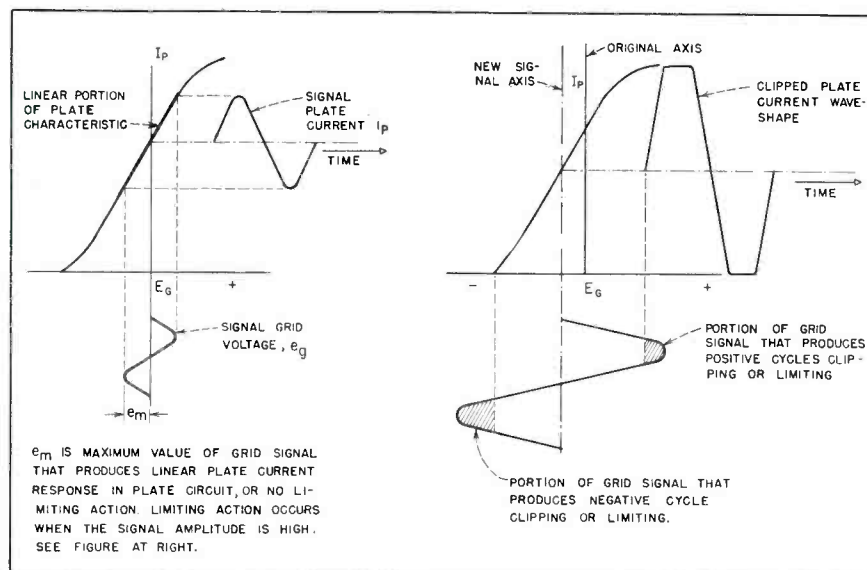
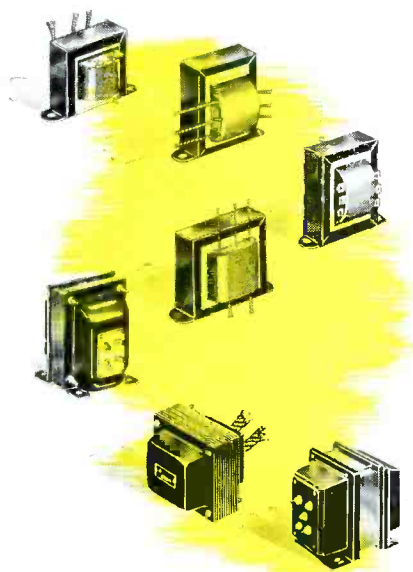
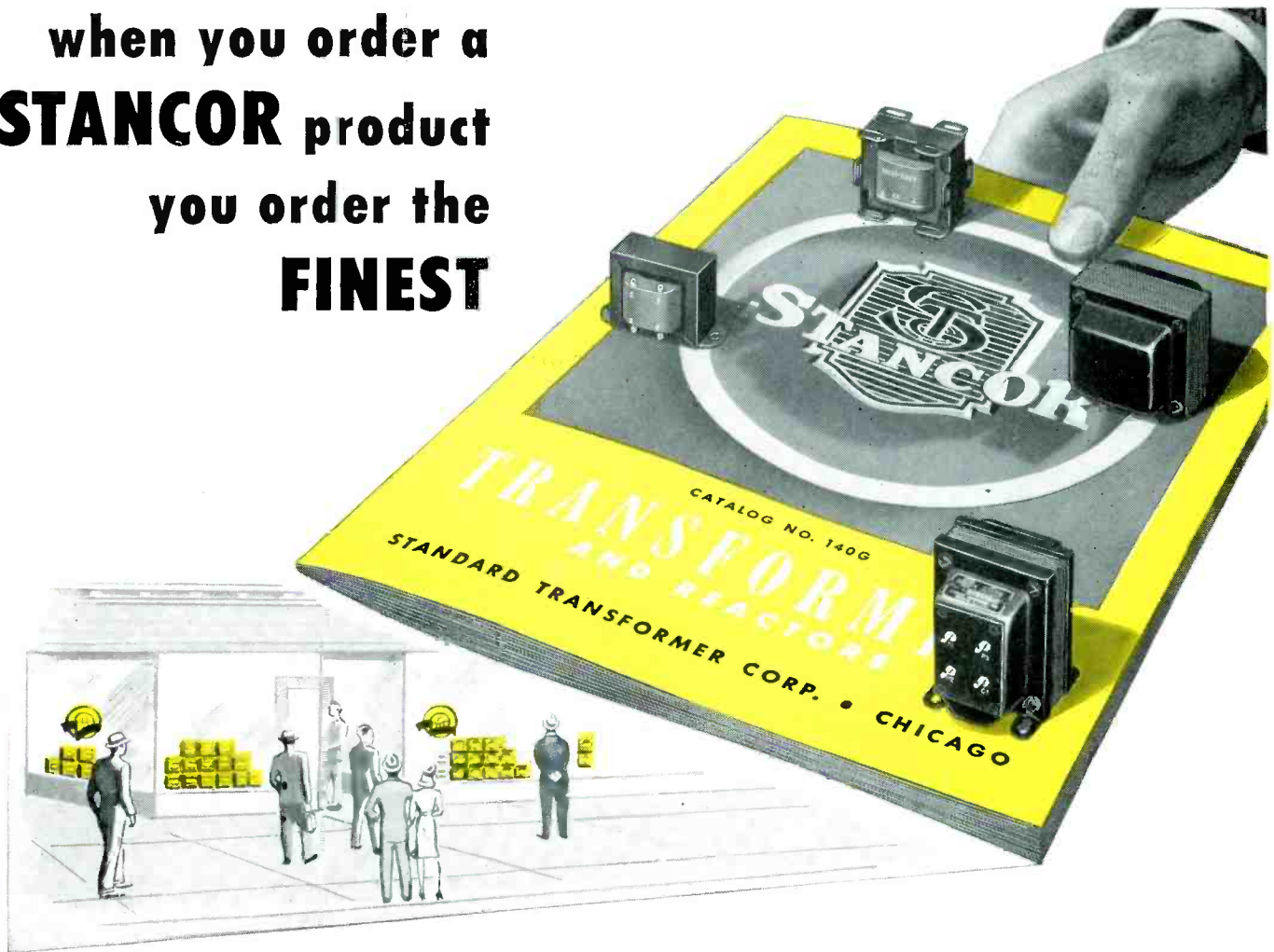

Figure 3

when you order a  
**STANCOR** product  
 you order the  
**FINEST**



The big black-and-yellow STANCOR catalog is the logical place for the radio serviceman to turn for a transformer to meet any standard need. . . . For there you will find the most complete selection of Replacement and General Purpose Transformers. . . . And there you'll find the FINEST. . . . For the most exacting quality is built into every STANCOR product. . . . Quality plus advanced design and universal application. . . . Yes, reach for the well-thumbed STANCOR catalog . . . for behind it are STANCOR's new streamlined plant facilities to give you better products and better service . . . to help you give your customers complete and lasting satisfaction.

standardize on **STANCOR**



**TRANSFORMERS**

STANDARD TRANSFORMER CORPORATION • ELSTON, KEDZIE AND ADDISON, CHICAGO, ILL.

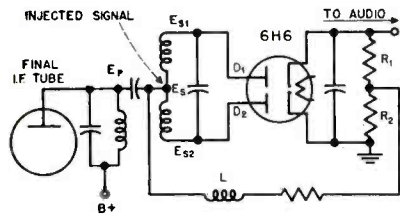

Figure 4

tude variations. Commonly referred to as the discriminator, it contains a transformer which has a center-tapped secondary. The dual-diode detector tube in conjunction with the center-tapped secondary results in full wave detection. However, in addition to the induced signal that appears in the secondary, an out-of-phase signal from the primary is injected into the secondary as shown in Fig. 4 resulting in signals on both diode plates which are the vector sums of the induced and injected voltages in series.

At an incoming carrier frequency which is in resonance with the secondary the vector sums of the voltages in both halves of the secondary are equal (see Fig. 5a), and the rectified voltage drops across the diode load resistors  $R_1$  and  $R_2$  cancel each other. No audio voltage is therefore present. As the carrier frequency is increased due to the influence of an audio signal one of the vectors increases in magnitude and another decreases as shown in Fig. 5b. This results in unequal voltages appearing at the diode plates and a resultant voltage across the two diode load resistors. The corresponding frequency deviation of the carrier in the opposite direction due to the same audio signal produces a voltage across the diode load resistors of equal amplitude but negative polarity. See Fig. 5c. Thus, an a-c voltage is produced across the diode load resistors the amplitude of which is proportional to frequency deviations of the carrier

(the amplitude of the modulating audio signal), and the frequency of which is proportional to the audio frequency component in the carrier.

With this background of knowledge\* pertaining to the operation of an FM receiver it becomes a relatively simple matter to realign its stages with the equipment outlined at the outset of this article. For purposes of illustration we will consider first the alignment of the Stromberg-Carlson No. 425 receiver, the schematic of which is shown in Fig. 6. The instruments used in aligning this receiver were a Precision Series E-200-C signal generator and a Supreme No. 592 VOM.

### ALIGNMENT PROCEDURE

The first step is to align the primary and secondary trimmers of the discriminator transformer. To do this connect the output cable of the signal generator between grid and ground of the limiter tube. If two limiter tubes are used the signal generator is connected across the grid circuit of the second limiter tube. The VOM is now connected across both cathodes of the discriminator. A VTVM may also be used for this purpose. With the signal generator set for an unmodulated signal at the i-f frequency specified by the manufacturer, the *Primary* trimmer is first adjusted for *Maximum* output on the indicating meter. Following this the *Secondary* trimmer is adjusted for *Minimum* output on the meter scale. It may be found that when adjusting the secondary three positions of the trimmer will result in a minimum reading. The correct position is the one where a slight rotation of the trimmer in either direction of the minimum position increases the meter reading.

\*Complete details on FM receiver circuits and their functions are covered in the series of articles: "Frequency Modulation" currently appearing in RADIO SERVICE DEALER.

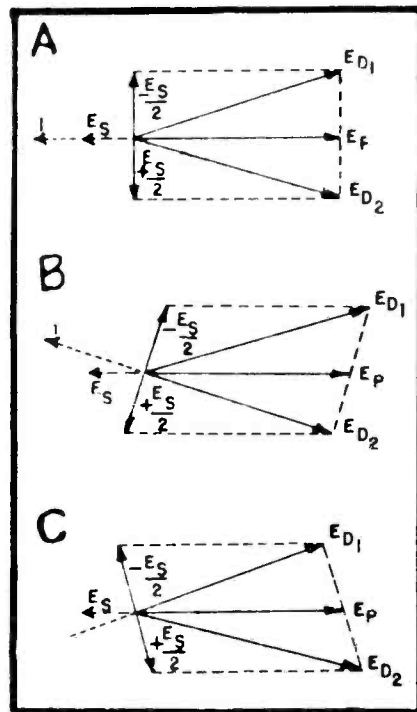

Figure 5

The VOM is now connected in series with the ground return of the grid resistor of the limiter, with the instrument set at the most suitable micro-amp range. If a VTVM is used the meter is connected across this grid resistor, using the lowest scale that will render satisfactory readings. The i-f trimmers of the various stages are now aligned for *maximum* output starting with the last i-f stage and proceeding to the first as in the conventional superheterodyne. The setting of the signal generator must not be disturbed from the original position of the dial setting where the original discriminator adjustments were made.

In some receivers it will be found that the i-f transformers are over-coupled to obtain a broad band-pass characteristic. When aligning this type

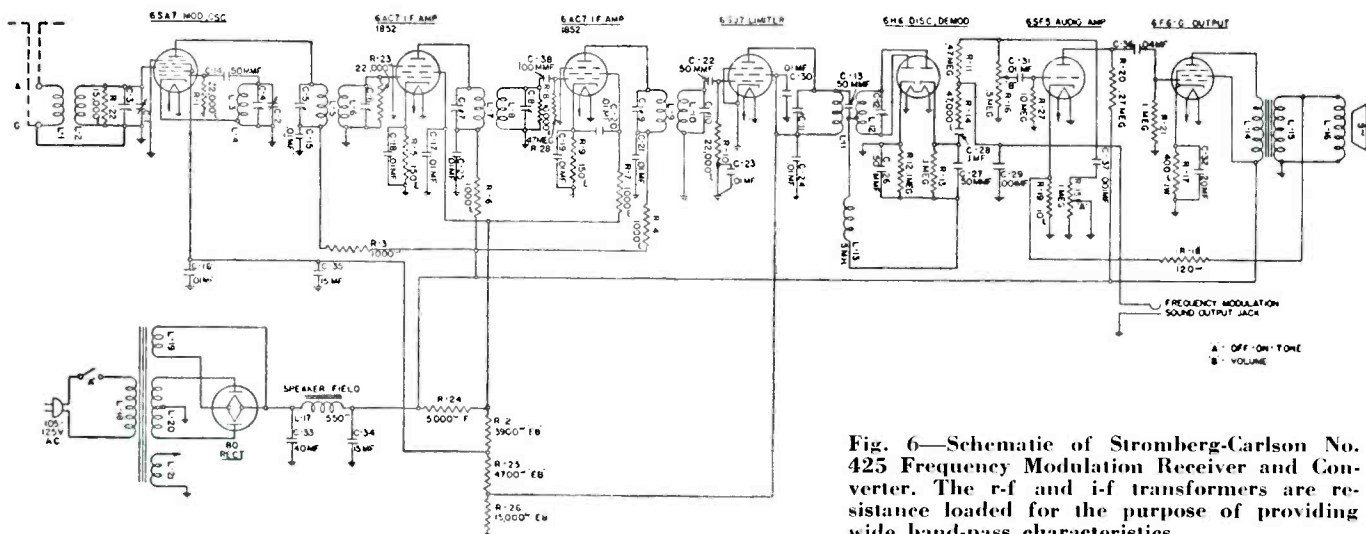

Fig. 6—Schematic of Stromberg-Carlson No. 425 Frequency Modulation Receiver and Converter. The r-f and i-f transformers are resistance loaded for the purpose of providing wide band-pass characteristics.

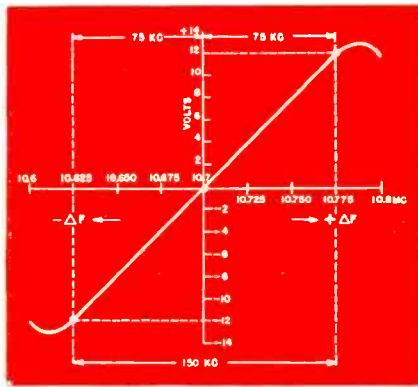

Figure 7

of i-f transformer it will be found that two consecutive peaks are obtained when each trimmer is rotated. The procedure in this case is to adjust each trimmer for a dip *between* these peaks. This occurs when both adjustments result in the same output meter readings. It is advisable at this point to repeat all the foregoing adjustments, starting with the discriminator and ending with the first I.F. This is to insure symmetry of response in the discriminator and in the i-f stages.

In order to check response symmetry in the i-f stages, the signal generator is shifted 50 to 100 kc on each side of resonance, at the same time observing the grid current in the limiter stage. Symmetrically aligned i-f transformers will give fairly equal but opposite readings for equal and opposite frequency deviations from resonance. The linearity of the discriminator is checked in a similar manner, the voltmeter being connected now across both diodes of the discriminator. A typical deviation graph for a discriminator stage is shown in Fig. 7.

### Aligning Oscillator Circuit

The alignment of the oscillator and r-f trimmers is conventional. The signal generator is set at approximately 105 mc, and the receiver dial to this same setting. Then, with the output indicating meter connected in the grid circuit of the limiter, the oscillator and r-f trimmers are tuned consecutively for maximum output.

An interesting variation in the alignment procedure just outlined is suggested by the Westinghouse Service Department Laboratories for the Model H-119. The operations are as follows:

Connect a 10,000 ohms-per-volt meter, or VTVM between the Discriminator test jack and the chassis. (The Model H-119 contains a separate test jack for FM alignment.)

With the volume control set for maximum output and the signal from the generator attenuated to avoid AVC action, proceed as shown in Table I.

It will be observed that the procedure varies insofar as the discriminator transformer is first detuned, thereby permitting *all* adjustments to be observed on the meter connected across the diode cathode connections of the discriminator. This is a time-saving procedure. Notice that the final adjustment is made on the discriminator transformer.

### FM Ratio Detector Alignment

The alignment of FM receivers employing ratio detectors, an example of which is shown in the partial schematic of the Farnsworth GK-140 in Fig. 8, is comparatively simple. This is illustrated in following alignment procedure recommended by their service department:

Equipment necessary: R-F Signal Generator and VTVM

1. Connect VTVM from ground to audio lead of ratio detector (discriminator). Connect generator tuned to 10.7 mc to grid of third FM i-f tube through .01 mfd mica capacitor. Use minimum signal necessary for good indication in all following:

2. Turn secondary slug of ratio detector transformer (top slug) out as far as it will turn.

3. Tune primary for maximum output.

4. Connect generator to grid of second FM i-f tube.

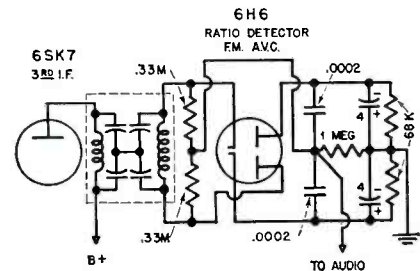

Figure 8

5. Tune primary and secondary of third FM i-f transformer for maximum output.

6. Connect generator to grid of first FM i-f tube.

7. Tune primary and secondary of second FM i-f transformer for maximum output.

8. Connect generator to converter grid through 10,000 ohm resistor and .1 mfd capacitor.

9. Tune primary and secondary of first FM i-f transformer for maximum output.

10. Tune secondary of ratio detector transformer for zero or minimum output.

11. The FM i-f system should now be aligned. Tuning the signal generator equal amounts on each side 10.7 mc should produce equal deflections of opposite polarity on the VTVM. Deflections unequal by more than 10 per cent or so indicate inaccurate alignment.

TABLE I

STEP	CONNECT SIGNAL GENERATOR TO...	SIGNAL GENERATOR FREQUENCY	RADIO DIAL SETTING	ADJUST
1	Set Phono-Band switch to "F.M."			
2	Detune secondary trimmer of discriminator transformer.			
3	6SG7, 2nd i-f, control grid through a .01 mfd mica capacitor	UNMODULATED 10.7 mc	88 mc	10.7 mc primary trimmer of 3rd i-f trans. for maximum voltage.
4	6SG7, 1st i-f, control grid through a .01 mfd mica capacitor	UNMODULATED 10.7 mc	88 mc	10.7 mc secondary and primary trimmers of 2nd i-f trans. for maximum voltage.
5	Fixed plates of the FM converter tuning capacitor through a .01 mfd mica capacitor	UNMODULATED 10.7 mc	88 mc	10.7 mc secondary and primary trimmers of 1st i-f transformer for maximum voltage.
6	Fixed plates of the FM converter tuning capacitor through a .01 mfd mica capacitor	UNMODULATED 10.7 mc	88 mc	carefully "peak" all 10.7 mc i-f trimmers for maximum voltage.
7	FM antenna terminal through a non-inductive 300 ohm resistor	UNMODULATED 105 mc	105 mc	FM oscillator trimmer for maximum voltage.
8	FM antenna terminal through a non-inductive 300 ohm resistor	UNMODULATED 105 mc	105 mc	FM r-f and ANT trimmers for maximum voltage.
9	Fixed plates of the FM converter tuning capacitor through a .01 mfd mica capacitor	UNMODULATED 10.7 mc	88 mc	Primary trimmer of discriminator transformer for maximum voltage.
10	Fixed plates of the FM converter tuning capacitor through a .01 mfd mica capacitor	UNMODULATED 10.7 mc	88 mc	Secondary trimmer of discriminator transformer for zero voltage. The voltage will change polarity as the trimmer is tuned through resonance. Tune carefully for zero voltage.
11	Re-check steps 9 and 10.			

# SHOP NOTES

Write up any "tricks-of-the-trade" in radio servicing that you have discovered. We pay from \$1 to \$5 for such previously unpublished "SHOP NOTES" found acceptable. Send your data to "Shop Notes Editor."

## IGNITION INTERFERENCE IN AUTO RADIO RECEIVERS

It would not be amiss at this date, with the advent of increased activity in auto radio installations and service, to point out the important steps in ignition interference elimination. A summary of these points by Zenith follows:

Remove the center high tension lead of the distributor and insert the suppressor into the distributor at that point. The wire is then placed in the open end of the suppressor. The generator condenser is fastened under the cut-out housing and the wire connected to the generator connection on the cut-out. The coil condenser is attached to the battery connection of the coil and the other end to the coil case. Make absolutely certain that this condenser is not accidentally connected to the distributor side of the coil since this will increase motor noise terrifically and make operation of the receiver highly unsatisfactory when the motor is running. Where two distributors or two coils are employed a corresponding number of condensers and suppressors must be applied. In some instances it might be of benefit to attach a by-pass condenser from one side of the ammeter to a grounded part of the instrument panel. If the dome light is feeding interference to the antenna the lead should be cut where it comes from the post and a switch inserted on the panel at that point, to turn it off and on. In some cases, a by-pass condenser connected to the dome light lead and grounded at the post is as effective as a separate switch. Try this first.

If additional attention is necessary to reduce motor interference, the motor block must be securely bonded, both at the rear and front supports with 1/2 inch copper braid. Also bond or ground all metal control cables or pipes feeding from the motor side into the car. These bonds should be made to the control wire or pipe and soldered to the fire wall immediately adjacent on the motor side. As a further precaution the rotor should be lengthened to reduce the gap between it and the distributor head contacts by either peening the end or applying a small quantity of solder at this point.

## REPLACING NYLON KNEE NEEDLE IN ASTATIC PICKUPS

An excellent list of operations pertaining to the replacement of the nylon knee needle in Astatic pickups has been prepared by the Astatic Corporation, and is given below.

- A. Insert 2-64 ejection screw 1 into hole 2.
- B. Turn screw until you see and feel the needle loosen.
- C. Remove ejection screw 1.
- D. Remove loosened needle 6.

E. Insert new needle with locating fin 8 and sapphire tip 7 toward the front.

F. Press in as far as possible by pressing *straight* down on the knee of the needle 6.

G. Using the corner of a small screw driver, place it on the top of the needle 6 and press straight down hard until you feel the paper needle 6 slide into the chuck 5 and the fin 8 bottoms on the chuck 5. Great care should be exercised so as not to damage the sapphire playing tip 7. Pressure should never be applied to the playing tip 7.

## R.C.A. VICTOR MODELS TRK-9, TRK-12, TRK-90 TRK-120

These R. C. A. service notes, although prepared for the above models, apply equally well, with slight modifications to all television receivers.

*Distorted sound, or sound in picture.* An open in one side of the antenna transmission line can cause distorted sound. Other possibilities include:

(a) If the sound-response curve is not linear for 75 kilocycles on each side of 8.25 mc., distortion will result.

(b) Inaccurate adjustment of the oscillator frequency on any channel may result in no sound or distorted sound, due to the fact that the second i-f beat frequency will not be 8.25 mc. If the oscillator frequency is too low, the beat note, instead of falling on the high-frequency slope of the i-f response curve, may fall on the low-frequency slope. In this case, the sound may be satisfactory, but operation on this side of the curve should be avoided. In some localities, it results in sound image interference from other channels.

*A quick and definite method to check the oscillator frequency is as follows:*

- (a) Tune in a television station.
- (b) Turn the fine tuning trimmer to

minimum capacity. This should produce some evidence of sound in the picture. The sound usually appears as horizontal bars of varying density, and these varying in step with the speech or music. The bars disappear when the voice or music stops.

(c) Turn the trimmer for best sound quality. This should correspond approximately half-capacity of the trimmer.

(d) Turn the trimmer toward maximum capacity. If the slope of the sound i-f response curve, is narrow, this will move the beat on to the peak of the response curve, producing low volume and severe distortion.

On service work in the home or where test equipment is not available, if one or more of the oscillator frequencies require readjustment, the recommended procedure is as follows:

(a) Tune in the television station on the channel which requires re-adjustment of the oscillator frequency.

(b) Turn the fine-tuning trimmer to minimum capacity.

(c) Turn the magnetite-core for the particular oscillator coil toward the highest frequency position (core moved away from the coil). This will definitely put sound in the picture. Turn the core in the opposite direction, to lower the oscillator frequency, until the sound is barely perceptible in the picture. Leave the core in this position.

(d) Now, by turning the fine-tuning trimmer to half-capacity, it should be possible to secure good tone quality with no trace of sound in the picture.

If the sound I.F. is deliberately moved into the picture I.F. by adjusting the oscillator core to produce the highest frequency, the effect of the sound i-f interference will produce a "reversed" image, somewhat like a film negative.

The customer should be instructed to adjust the fine-tuning control for best sound quality, at which point there is no sound in the picture. If the set is turned on in a cold room, it may be necessary for the customer to readjust the fine-tuning trimmer to compensate for the slight drift in oscillator frequency during the warm-up period.

On all converted receivers, the fine-tuning trimmer is permanently fastened to the fine-tuning controls, so that it is not necessary to press in on the control knob. ("C" washers are slipped between the end of the shaft and the rubber drive and cement is used between the rubber drive cone and the cup on the fine-tuning trimmer.).

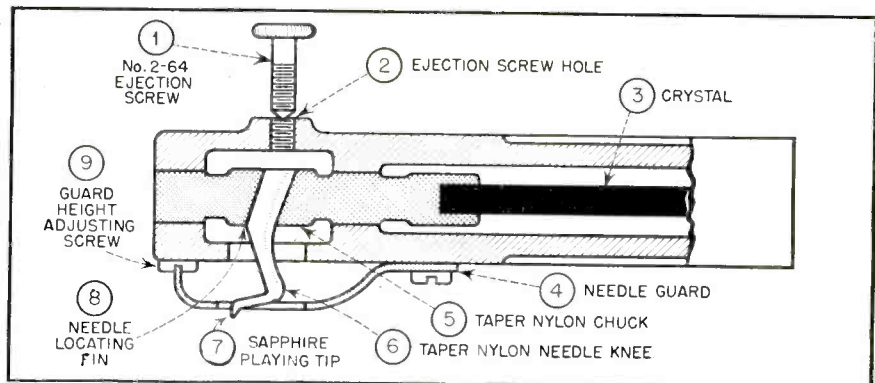

Open, side-view of Astatic pickup showing how Nylon replacement needle should be inserted.





# SPRAGUE TRADING POST

## .. A Mighty Good Thing to Have Around Your Shop or Store

See your Sprague jobber! Buy 6 Sprague IF-37 Interference Filters mounted and displayed on this attractive card. Use it on your counter, on the wall or in the window. Let customers know that you can now give prompt, effective service in reducing radio interference from fluorescent lights—even the kind that is conducted down power lines to re-

motely located fixtures. Sell IF-37's to customers who want to make their own interference suppression installations. *And be sure to install filters on fluorescent lights in your own store to assure better, quieter radio and television demonstrations.* Use one IF-37 Filter with each fluorescent auxiliary—and watch radio noises disappear!

### SWAP • BUY • SELL

**SELL OR SWAP**—803, 801/A, 843, 1616 (2), miscellaneous transmitting condensers, switches, parts, etc. Want plate transformer with about 3000v c.t., W9MDG, 3428 W. St. Paul Ave., Milwaukee 8, Wis.

**WANTED**—Meters, xformers, etc. to be used in ham rig. Will buy or swap. Eddie Howell, 501 W. Harden St., Graham, N. C.

**WANTED**—Mounting Frame, connecting cables, remote and instruction book for navy type RT-19/AHC-4. Robert Hass, W6WUF, Box 1161 Port Arthur, Texas.

**SWAP**—Hickok Electronic volt-ohm-milliammeter model 202N for reliable make signal generator in good condition. Harro C. Beyer, W7KIP, 1366 S. West Temple, Salt Lake City 4, Utah.

**WANTED**—2 midget transceiver transformers: either Inca I-45 or similar. New or slightly used. H. G. Barngrove, Jr., 8901 Eager Road, St. Louis County, Mo.

**WILL TRADE**—Meissner ECO exciter for all bands except 10 meters and up. Also Agfa 16mm movie camera with F:1.5 lens. Want IIT-6 transmitter. Write Virgil Houser, W9KTX North Liberty, Ind.

**WANTED**—Good communications receiver prefer S-40, S-20-R, RME-84 or RME-69. Not over \$60. John Pattison, Grand View Drive, Peoria 4, Ill.

**WILL TRADE**—German field binoculars 10 x 80 perfect condition. Want good ham receiver or what have you? C. Rorvewich, W2GWZ, 1066 President St., Brooklyn 25, N. Y.

**FOR SALE**—Hammarlund HQ-129-X receiver. \$170. Also National NC 1-10 receiver, complete with tubes. \$55. Abbott TR-4. 2 meter xmitter receiver with tubes. \$45 R. K. Forsberg, WINWII, 39 Kosta St., Worcester 7, Mass.

**WANTED**—Thordarson, Stancor or Kenyon plate transformers 12.50 and 1500v d-c output at 300 mills and 17.50v d-c and 2000v d-c or 2000v d-c and 2500v d-c at 300 ma. Also swinging and filter smoothing chokes for them. Don Denivers, W2NLH, 210 Rector St., Perth Amboy, N. J.

**SELL OR TRADE**—75 Random copies QST from 1925 to 1936. Want transmitter components, Plate transformers, tubes, etc. or will sell for \$25. Sidney L. Ross, 315 S. Chestnut St., Lafayette, La.

**WILL TRADE**—Superior, model 650, signal generator, brand new; for communications receiver RC-348 or what have you? G. D. Pugsley, Box 142, Brockport, N. Y.

**WANTED**—High fidelity tuner with 5 or 6 tubes for use with high fidelity amplifier or other receiving set for this use. Frank W. Jones, Gabbs, Nevada.

**SELL OR TRADE**—Jewell 54 voltmeter 0-15 dc; Jewell 135-B-voltmeter 0-8-200 d-c; Esco converter 32 d-c to 110 a-c with filter; G-E dynamotor 24 d-c to 750 d-c @ 200 ma; Superior 1140-S tube tester; several R & M 32v fans and miscellaneous ham gear. Want com. receiver. H. W. Ray, Indianola, Miss.

**WANTED**—for shipboard operation, Hallcrafters HT-9 xmitter. State price and condition. J. Scherbanic, W3KKV; 1748 Ninth St., Port Arthur, Texas.

**FOR SALE**—20% off list—3LE4, 1LD5, 3A4, XXFM, 2E5, 1S4, 1P5, 12AH7, XXD, XNB, 306/299 12SM7, 6SL7, 6SN7, 6SH7, 25B5, 6Y6, 1629, 7E6, 1LH4, 9003, 7A6, 1LA4, 7L7, 7A5, 43Z5, 35Z4, 50Y6, 12SP5. All new, one or more of each. Post paid. C. C. Butler, 616 E. 5th St., Cherryvale, Kans.

**FOR SALE**—Audak Pro-3 pickup. UTC line matching transformer T-Pad. \$45. H. C. Dunkley, 285 Pomeroy Ave., Pittsfield, Mass.

**WANTED**—Power supply, 110v A.C. input, 12v, 12-amps. D.C. output. Roland Crim, 1223 Circle Tower Bldg., Indianapolis, Ind.

**FOR SALE**—Tubes 18-954, 6-955, 6-956, 57-6B8, 36-6K8, and 26, 3B7. Whole lot \$100. FOR. Aide Sound & Radio Service Corp., 3135 West 59th St., Chicago, Ill.

**FOR SALE**—Telrad model 18A frequency standard, \$29. O. J. Rasmussen, 1129 N. 26th St., Billings, Mont.

**FOR SALE OR TRADE**—Hallcrafters S-27 receiver—FM-AM, 27 to 148 mc. A-1 with 8" Jensen speaker. R. Kelleman, 1614 S. 19th Ave., Maywood, Ill.

**SELL OR TRADE**—Vomax new—need signal generator or will sell reasonably. E. L. Felder, Box 184, Tylertown, Miss.

**WANTED**—Three band antenna coil for Delco ten tube radio model R1118. Can substitute Delco coil #1211409. Williams Radio Service, 9 Myrtle St., Portland 3, Maine.

**FOR SALE**—No. 19 Mark II 80 & 40 meter phone-CW rig, dynamotor, 115 volt a-c, 12v @ 12 amps. d-c power supply, earphones, mikes, variometer and complete antenna. Jack Bolman, 153 Kingsboro Ave., Gloversville, N. Y.

**FOR SALE**—RME 45 receiver complete with speaker. Like new. \$150 cash. Harold B. Moore, 215 Highland Ave., East Gadsden, Ala.

**FOR SALE**—Riders manuals—Vols. 1 through 4. Like new—cash only. Write for list of other radio books. R. E. Green, 703 N. County St., Waukegan, Ill.

**WILL TRADE**—Two RCA Model AVR-20-A. Four tube super, 2800, 6500 kc. receivers. Excellent for 75 Fone—CW. Use in plane or car. One Setchel-Carlson #591 5-tube 200-400 kc. battery-operated aircraft receiver. Want binoculars, HV transformers or what have you. Russell M. Short, 1509 N. 16th St., Boise, Idaho.

**FOR SALE**—Signal tracer CA-11 brand new with instructions, \$12.50. Joseph F. Brown, 34-05 28th Ave., Long Island City 3, N. Y.

**WILL SWAP**—New #450 Superior tube tester for Riders Manuals. Alex Shapiro, 258 Milford St., Brooklyn, N. Y.

**FOR SALE**—Hallcrafters S-38 complete. Like new, used very few hours. \$37.50. E. A. Goodbout 503 N. Genesee St., Waukegan, Ill.

**FOR SALE**—Complete radio shop including 600 tubes; Rider manuals; Precision tester 864; Jackson osc. 441-A; Precision tube tester 910; Triplett 1125-B; BN condenser tester and hundreds of other items. Send for list. Diaz Radio, 748 Westchester Ave., New York 55, N. Y.

**FOR SALE**—Rider manuals 1 to 14 inclusive, 14 volts. Binders and contents perfect and complete, with all indexes and booklets. Will ship express C.O.D. immediately upon receipt of \$150 cash or money order. H. Parker, 609 Ridge Ave., N.E., Pittsburgh 12, Penna.

**FOR SALE**—Radio service and appliance store, have Philco, Norge, Delco, Sentinel franchises. Town of 3000 pop., and immense farming territory. Am selling because of other interests. L. E. Frost, P. O. Box 136, Sandwich, Ill.

**SELL OR SWAP**—12 rectifier tubes F.W., \$1.25 ea; 12 4-prong vibrators to match, 6V., \$1 ea; 3-307-xmitting tubes, \$2.50 ea; 10 dual selenium rectifiers 2 v., 250 mill. and 6 V., 110 mill., \$1.25 ea. Need tube tester, sig. gen., VOM meter. Thap Klaus, 1324 N. Bosworth Ave., Chicago 22, Ill.

**FOR SALE**—Radio—Electric appliance and gift shop, old established business, high class, best franchises, wonderful opportunity for right parties. Building included 5-point corner, best in town. Traffic average 5000 cars per day. W. L. Davis, No. 2 Broadway, Kissimmee, Fla.

**WANTED**—3" or 5" scope and Precision E-200 sig. gen. or equal. Both must be in good condition. E. W. Moreland, 891 E. Normal St., Springfield, Mo.

**FOR SALE**—Radio tubes: 89's; 200A's; 20(120)'s; WD-12's. 25¢ ea. Webster Radio Shop, 418 N. 16th St., Omaha 2, Neb.

**SELL OR SWAP**—CB-1-16 capacitor analyzer and signal tracer with B plus power supply, for Waterman S-10-A pocketscope. Johnnie's Radio Service, Rock Valley, Iowa.

**FOR SALE**—28 V. input, outputs: 575 V at 160 ma. \$5; 250 C at 60 ma., \$3; 250 V. at 60 ma., \$2 ea; 14V. input, output 230 V. at 100 ma., \$3; 12 V. input, output 480 V. at 40 ma., \$3. Bill D. Wilson, 2703 Bentley Ave., Dallas 11, Tex.

**WANTED**—Radio News magazines from July '46 to May '47, with the RN circuit files still in them. Cash or trade rubber stamps or 13 copies Craftsman Mag's. for same. Cookson, Lock Box 0, Puxico, Mo.

### YOUR OWN AD RUN HERE FREE

The Sprague Trading Post is a free advertising service for the benefit of our radio friends. Providing only that it fits in with the spirit of this service, we'll gladly run your own ad in the first available issue of one of the six radio magazines in which this feature appears. Write CAREFULLY or print. Hold it to 40 words or less. Confine

it to radio subjects. Make sure your meaning is clear. No commercial advertising or the offering of merchandise to the highest bidder is acceptable. Sprague of course, assumes no responsibility in connection with merchandise bought or sold through these columns or for the resulting transactions.

Send your ad to Dept. RM-67

**SPRAGUE PRODUCTS COMPANY, North Adams, Mass.**

(Jobbing distributing organization for products of the Sprague Electric Co.)

**ASK FOR SPRAGUE CAPACITORS and \*KOOLOHM RESISTORS by name!**

\*Trademark Reg. U. S. Pat. Off.

# NEW PRODUCTS

**T**WO new Tube Testers, Models 305 RC and 330 RC, are announced by the Simpson Electric Company, Chicago, Illinois.

The new testers are 1947 versions of the company's popular Models 305 and 330. The former, a standard type tester, is known for its utility and its 3-way switching arrangement which makes possible the testing of any tube regardless of base connections or the internal connections of its elements. The Model 330 is the Mutual Conductance Tube Tester announced by Simpson last year.



**SIMPSON MODEL 305 RC.**

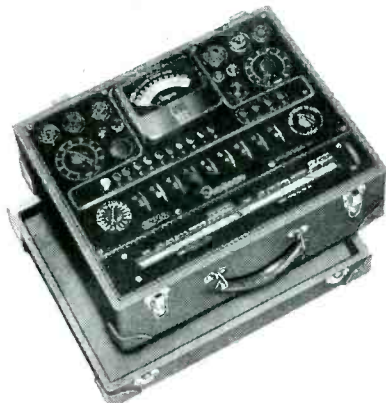

**SIMPSON MODEL 330 RC.**

To both these instruments has been added the "No-Backlash" Roll Chart. This automatically takes up the slack in the paper chart and, by keeping the chart in constant tension, makes it impossible to turn the selector wheel without moving the chart. It prevents the paper chart from tearing and getting out of alignment, and presents at all times a neat, flat reading surface. The gearing is such that a mere 6 turns of the selector wheel will run the entire length of the 12½ foot chart of the Model 305RC, and 3 turns will run the chart on the Model 330RC.

Model 305 provides for filament voltages from .5 volts to and including 120 volts. Tests octals, single ended tubes, bantams, midgets, miniatures, ballast tubes, gaseous rectifiers, acorn tubes, Christmas tree bulbs and all popular radio receiver tubes; also pilots lamps of various voltages. Has neon bulb for checking shorts; the tester is fused, and provides for line adjustment from 100 to 130 volts with smooth vernier controls.

Model 330RC, mutual conductance tester tests tubes in terms of percentage of rated dynamic mutual conductance—a comparison of the tube under test against the standard rated microhmho value of that tube. Tubes are tested with voltage applied automatically over the entire operation range, reproducing actual conditions under which a tube functions in a radio set.

## Mega-Sweep Announced

For the radio repair shop or service man, who is now testing and repairing FM and Television sets, the Kay Electric Company, 519 Main Street, East Orange, New Jersey, offers a new sweeping oscillator test unit that eliminates guess work and saves many hours of tedious alignment time.

The MEGA-SWEEP Jr gets its name from the fact that it is a service man's simplified model of a standard laboratory sweeping oscillator currently installed in most FM and Television laboratories, and in manufacturing plants. This Junior unit is designed to withstand hard shop service use.



It has a wide frequency spectrum coverage, providing a frequency sweep up to 30 megacycles over the entire frequency spectrum of 400 kilocycles to 500 megacycles. When necessary the output frequency may be increased to 1000 megacycles. Thus sweeps are furnished all through the color television frequency bands.

The testing of video, i.f. and r.f. amplifiers is possible because the octaves of frequency sweep show al-

most the entire video pass band at once, except for the lowest frequency end.

The output frequency is measured by means of a high precision microwave wave-meter, calibrated up to 900 megacycles, which covers the entire range without switching or complicated calibrations.



**Motorola Model WR8, automatic wireless record player. Changes ten 10-inch or eight 12-inch records; crystal pick up. Size 13"x8½"x14".**

## 4 x 4 x 8 Radio

Announced as the "tiniest" radio yet offered to the trade, the "Treasure Chest", product of the Sentinel Radio Corporation of Evanston, Illinois, is now in production and available to dealers. The set measures 4 inches in height, 4 inches in depth, and 8 inches in width.

It has five tubes and operates on AC, DC, and battery, and is available in two-tone plastic cabinets in a variety of colors. A program can be heard even when the cover is down, by hold-

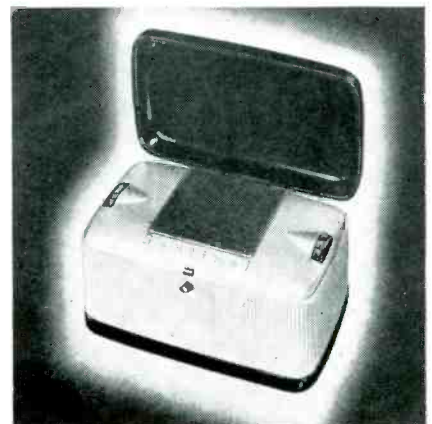

ing the radio to the ear. It can be used for travel and vacation purposes—at the beach, on trains, and in automobiles—at the ball game, on the office desk, and on the table at home. Ear-marked for a production of 100,000 this year, the portable will go into the hands of distributors promptly, accord-

[see page 26]

**For the Man Who Takes Pride in His Work**

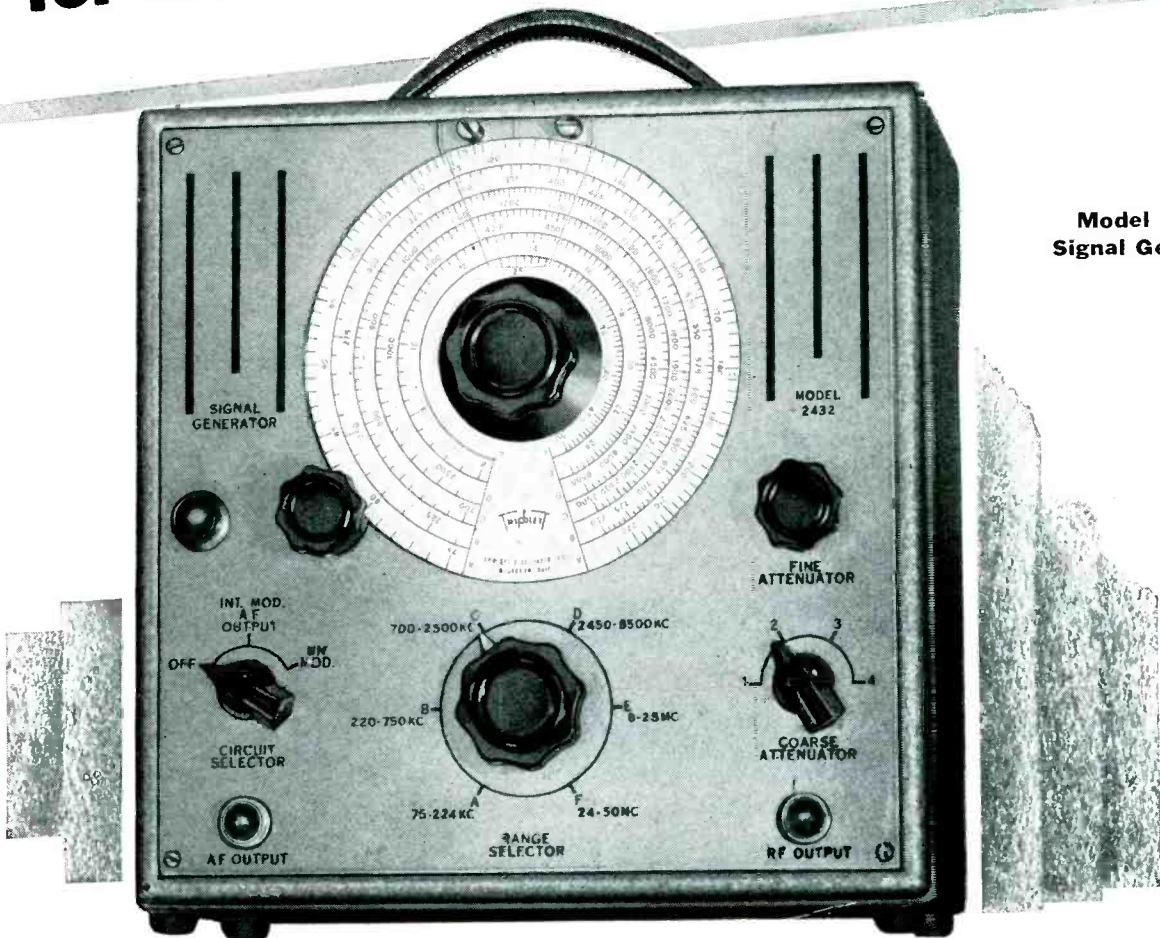

**Model 2432  
Signal Generator**

**FM AND TELEVISION BAND COVERAGE ON STRONG HARMONICS  
STRONG FUNDAMENTALS TO 50 (MC)**

Another member of the Triplet Square Line of matched units this signal generator embodies features normally found only in "custom priced" laboratory models.

**FREQUENCY COVERAGE**—Continuous and overlapping 75 KC to 50 MC. Six bands. All fundamentals. **TURRET TYPE COIL ASSEMBLY**—Six-position turret type coil switching with complete shielding. Coil assembly rotates inside a copper-plated steel shield. **ATTENUATION**—Individually shielded and adjustable, by fine and course

controls, to zero for all practical purposes. **STABILITY**—Greatly increased by use of air trimmer capacitors, electron coupled oscillator circuit, and permeability adjusted coils. **INTERNAL MODULATION**—Approximately 30% at 400 cycles. **POWER SUPPLY**—115 Volts, 50-60 cycles A.C. Voltage regulated for increased oscillator stability. **CASE**—Heavy metal with tan and brown hammered enamel finish.

There are many other features in this beautiful model of equal interest to the man who takes pride in his work.



**Triplet**

**ELECTRICAL INSTRUMENT CO. BLUFFTON, OHIO**

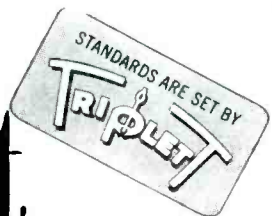

**MORE, BETTER JOBS PER DOLLAR.**

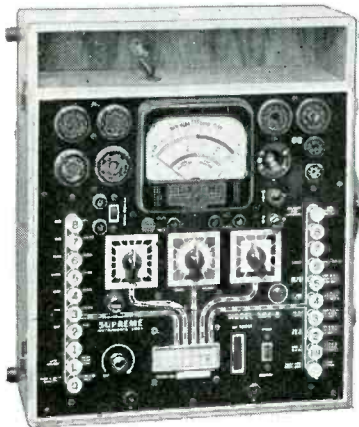

**SUPREME 504-B TUBE AND SET TESTER—**

the portable lab that gives you everything.

**ASK YOUR SUPREME JOBBER FOR A FREE DEMONSTRATION**



**WRITE TODAY FOR NEW CATALOG**

**HERE'S WHY AND HOW**

- **METER**—large 4-inch square-face meter, 500 microampere.
- **SPEED**—push-button operated.
- **FLEXIBLE**—simple, yet Universal Floating Filaments feature insures against obsolescence.
- **SIMPLICITY**—roll chart carries full data for tube setting. No roaming test leads when using multi-meter—only push a button.

**SPECIFICATIONS**

DC VOLTS—1000 Ohms per volt: 0-5-25-100-250-500-1000-2500.  
AC VOLTS—0-5-10-50-250-1000.  
OUTPUT VOLTS—0-5-10-50-250-1000.  
OHMMETER—0-200-2000-20,000 Ohms, 0-2-20 Megohms.

**Condenser Check:**

Electrolytics checked on English reading scale at rated voltages of 25-50-100-200-250-300-450 volts.

**Battery Test:**

Check dry portable "A" and "B" batteries under load.

**SUPREME**

EXPORT DEPT.: The American Steel Export Co., Inc.  
347 Madison Ave., New York 17, N. Y., U. S. A.

**SUPREME INSTRUMENTS CORP., Greenwood, Miss., U. S. A.**

ing to Ernest Alschuler, president of the corporation.

Another model is a table-size combination that works automatically. It turns off and on as the lid is lifted or closed, and plays 7", 10", and 12" records. The third model is a mahogany Consolette, dubbed the "Baby Grand" of radio-phonographs. It has a generous compartment for record albums. It will be available with FM and/or AM. All three of the new Sentinels are scheduled to reach dealers shortly, simultaneously with a national advertising campaign.

**"Flex Spot" Flash-Lite**

Holub "Flex-Spot" Flash-Lites are available in three styles. They are equipped with a flexible *metallic* tubing which can be bent at *any* angle and held in the adjusted position. The tubing can be wound around rods, pipes, etc. or when laid on a ledge gives a spot light where wanted—thereby freeing both hands.

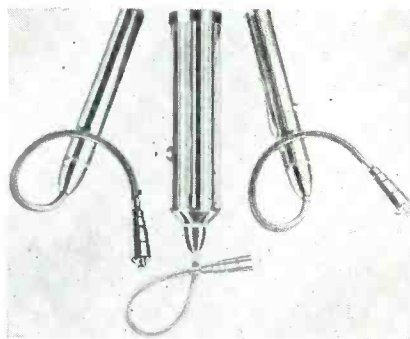

A powerful and shadowless light is spotted exactly where needed and wanted. The flexible tube permits entrance into very close or tiny quarters, gives a light around corners, the bottom side of panels or other objects and reaches into all hard-to-get-at places.

The Junior and Junior Deluxe models use two AA penlite type batteries and are intended for general use, whereas, the standard size uses two regular size flashlight cells for longer battery life, for use wherever heavy duty service is required. By Holub Industries, Inc., Sycamore, Ill.

**Resistance-Capacitance Bridge**

Model 76 Resistance - Capacitance Bridge is a new postwar general-utility instrument, just announced by Aerovox Corporation of New Bedford, Mass. It is equally suitable for use out on the job, in the shop, or at the hands of the laboratory technician. The high degree of accuracy of this low-priced bridge is due to its main 4-in. dia. dial with the same calibrated and linear scale for all functions. The absence of crowding at the high end makes for easier and more accurate readings. Both re-

**EXTRA Protection for EVERY Service Job!**

**FIXED OR ADJUSTABLE**

**VITROHM RESISTORS**



**AVAILABLE FROM STOCK**

Fixed Type in 8 Sizes from 5 Watts to 200 Watts  
Adjustable Type in 7 Sizes from 10 Watts to 200 Watts

You can guarantee dependable, trouble-free performance when you install VITROHM wire-wound resistors. Windings are held in place and protected by a special WL vitreous enamel which is tough, crazeless, moisture and acid-resistant. They give long service, avoid call-backs, build satisfied customers and greater profits. Available in wide range of resistance values.

*Authorized Distributors Everywhere*

**SEND FOR FREE CATALOG**

Write for Catalog No. D-2. Gives complete data and information.



**WARD LEONARD RELAYS • RESISTORS • RHEOSTATS**

Electric control devices since 1892

**WARD LEONARD ELECTRIC CO., Radio and Electronic Distributor Division, 53- W. Jackson, Chicago 4**

# Jensen

## Bass Reflex

### CABINETS

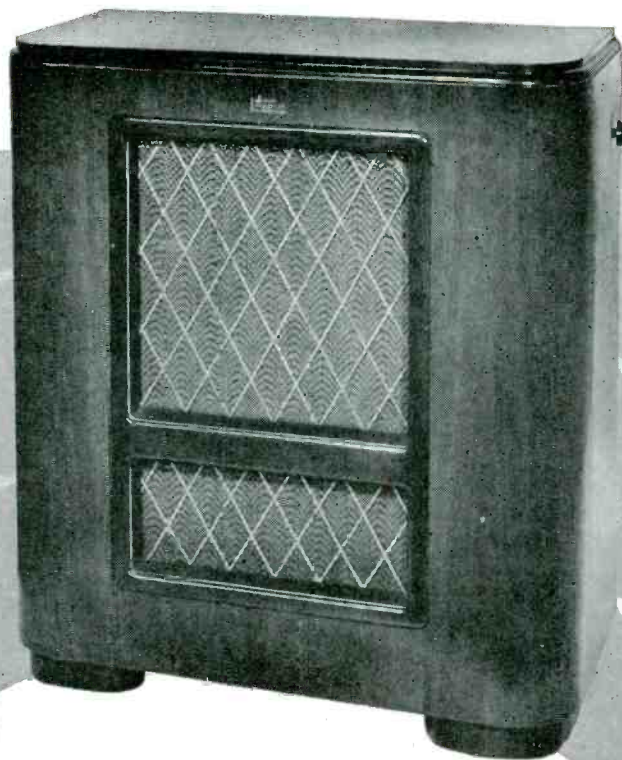

Three types—six models to accommodate 6", 8", 12" and 15" speakers



TYPE B Bass Reflex Cabinets are manufactured in sizes for 8", 12" and 15" speakers. A superior new wood composition in outer walls and panels assures distinguished appearance at a modest price. Finish is an attractive, baked-on hammerloid, trim is of chromium and aluminum.

**BASS REFLEX PRINCIPLE:** Through exact acoustical proportioning of the completely enclosed cabinet, and the use of an auxiliary port, the port is made an auxiliary radiator at low frequencies. This controlled use of what otherwise would be waste energy increases efficiency.

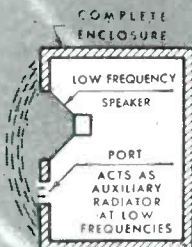

\*TYPE J PERI-DYNAMIC (Model J-61) CABINET is a wall-mounting style which takes any standard six inch speaker. Handsomely styled of a textured composition material, it is complete with mounting bracket. A five-lug terminal board facilitates installation.

Meeting the high engineering and appearance standards which for years have been a Jensen hallmark, these new Bass Reflex cabinets provide acoustically correct enclosures for Jensen speakers. They are particularly suitable for Jensen Coaxials.

All of them (except the J-61) employ the widely heralded Jensen Bass Reflex principle. This, together with special acoustical treatment, assures maximum extension of low frequency response, and freedom from objectionable "boom" or resonance.

See these new cabinets today at your dealers—or write for full information and prices.

ABOVE RIGHT: New Type D Deluxe Bass Reflex Cabinets are available for either 12" or 15" speakers. Exterior styling is by a noted designer; construction by one of the nation's foremost furniture manufacturers. All hard woods are of selected striped walnut. Finish is natural walnut rubbed to a satiny smoothness.

**JENSEN MANUFACTURING COMPANY**

6619 SOUTH LARAMIE AVENUE • CHICAGO 38, ILLINOIS

In Canada: Copper Wire Products, Ltd.,  
137 Oxford St., Guelph, Ontario



# Jensen

*Designers and Manufacturers of Fine Acoustic Equipment*

# R-MC TRANSCRIPTION PLAYER

(Patents applied for)

## Model TP-16C TURNTABLE and CASE only

In Carrying Position:  
23" w., 17½" h., 8" d.

### TWO-SPEED, 16-IN., LOW PRICE, FULLY PORTABLE, COMPACT, LIGHTWEIGHT, EASY TO CARRY.

Designed and built to meet the quantity production demand for a fine tone, dependable, and very low price transcription player. Available immediately. Advanced design, expertly engineered, and sturdily-built for trouble-free performance. Meets the demands of radio stations, transcription services, advertising agencies, and schools for realistic reproduction of transcription records up to 16 inches, 78 or 33⅓ r.p.m. Free of wow and rumble. Switch output impedance: 30, 250, and 500/600 ohms.

Constant speed heavy duty motor, silent, smooth operation. 16" TURNTABLE embodies special re-enforced construction (patent pending).

Bulletin TP11, upon request.



Available Through Authorized Jobbers

## RADIO-MUSIC CORPORATION

EAST PORT CHESTER

CONNECTICUT

12

*Smooth* RECORDING...  
*Smooth* PLAYBACK with  
**GI DUAL-SPEED HOME  
RECORDING ASSEMBLY**



'CUTS RECORDS UP TO 10" DIAMETER

PLAYS RECORDS UP TO 12"

ONE BUTTON CONTROLS SPEED  
78 or 33⅓ R.P.M.

JUST LOWER CUTTING ARM TO START RECORDING

You'll get quick response when you offer your customers this simple, dependable, Dual-Speed Home Recording Assembly.

It's simple as ABC to operate, with high-quality recording and fine reproduction. The sturdy, *Smooth Power* mechanism will stand up faithfully under hard home use—and it's remarkably low-priced to help you build volume sales.

Send for details. Ask us for complete information on the GI-R90 Home Recording and Phonograph Assembly—and on our complete line of Phonomotors, Recorders and Combination Record-Changer Recorders.



DEPT. MS • ELYRIA, OHIO

sistance and capacitance readings are covered by six overlapping ranges as against two or three in usual service instruments, for maximum sensitivity and accuracy. The "magic eye" null indicator provides the positive, snappy indication of balance.

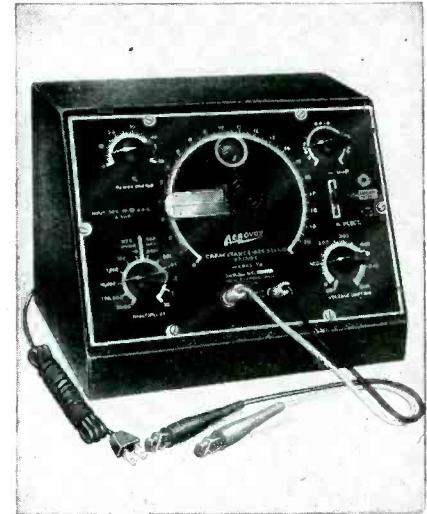

Here is what this Model 76 Bridge does: (1) Measures capacitance from 100 mmf. to 200 mfd. in six ranges. (2) measures resistance from 10 ohms to 200 megohms in six ranges. (3) measures power factor from 0 to 50%. (4) Provides D.C. polarizing potential for leakage measurements, from 0 to 600 v. D.C., continuously variable and calibrated in volts. (5) Checks leakage or insulation resistance in terms of "Good", "Fair" or "Bad". The instrument is provided with shockproof color-coded test leads fitted with banana plugs for the panel jacks, and with clips at the other end. Complete instructions with each instrument.

### Electron Tube Chart

Basic information on operation, types, and applications of electron tubes is presented in a new 25" by 36" wall chart printed in eight colors on

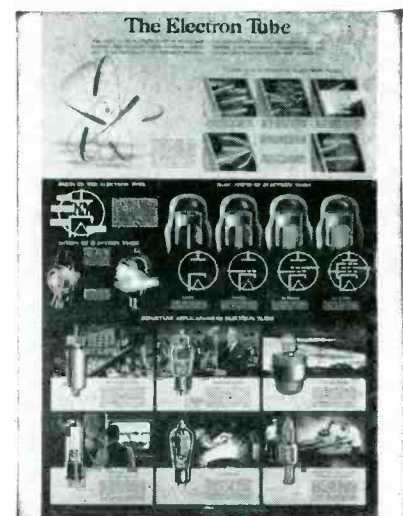

*Instantly—*

VOLTS

OHMS

MILS

DECIBELS

AMPERES

MICROAMPERES

*are at your fingertip!...*



with the **NEW** Precision *Multi-Master* Series **858**

**20,000 AND 1,000 OHMS PER VOLT**

**High speed, 54 range, dual-high sensitivity AC-DC de-luxe multi-range test set. Ranges to 6,000 volts—600 megohms—12 amperes—70 DB—60 microamperes.**

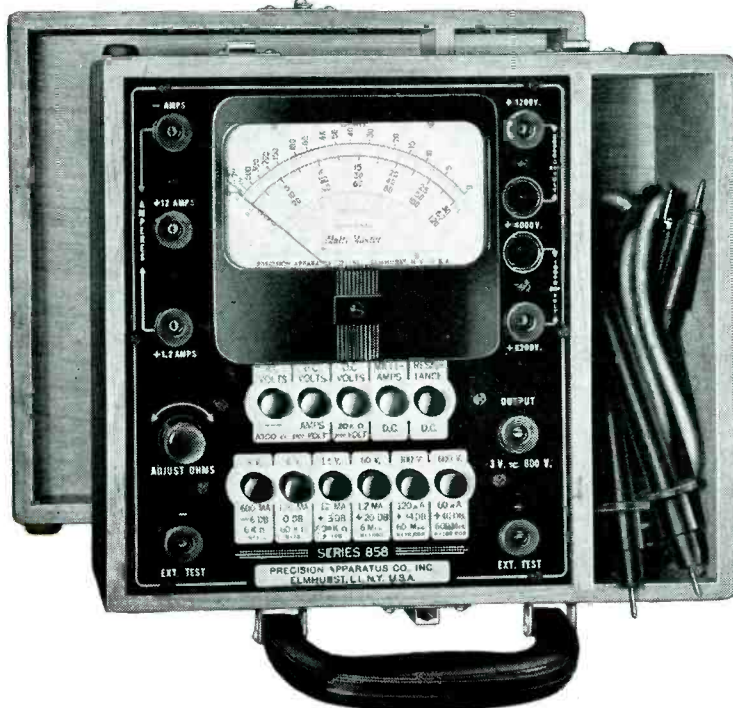

Series 858 MULTI-MASTER features "Precision" Automatic Push Button range and function selection, affording the ultimate in operational efficiency and simplicity.

A supersensitive test set particularly engineered for reliable, high speed measurements in modern electronic circuits ● Large, easy reading, 50 microampere, 4½" meter ● All standard functions available at only two polarized tip jacks ● 600 megohm insulation resistance test range in addition to 5 self-contained ohmmeter ranges to 60 megohms ● Recessed 6,000 volt safety jacks. Etched-Anodized aluminum panels resistant to moisture and wear ● Conservatively and professionally designed, the Series 858 keynotes the Precision standards of accuracy, workmanship and quality.

**RANGE SPECIFICATIONS**

- ★ 8 D.C. voltage ranges to 6,000 volts at 20,000 ohms per volt. Initial range 0-3 volts.
- ★ 8 D.C. voltage ranges to 6,000 volts at 1,000 ohms per volt.
- ★ 8 A.C. voltage ranges to 6,000 volts at 1,000 ohms per volt.
- ★ 8 D.C. current ranges to 12 amperes. Initial range 0-60 microamperes.
- ★ 6 ohmmeter ranges to 600 megohms. Initial range 0-6,000 ohms with 35 ohms center scale.
- ★ 8 decibel ranges from -26 DB to +70 DB.
- ★ 8 output ranges to 6,000 volts.

Model 858-L: modern, shallow, bakelite laboratory type case, size 7¾ x 8¾ x 3..... \$47.94

Model 858-P: portable, hardwood case with tool compartment and cover, size 8¾ x 10 x 4½..... \$49.94

( Complete with batteries and High Voltage test leads )

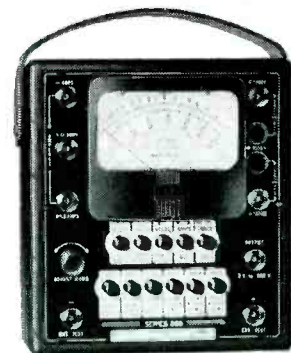

*Ask* to see the "Precision" line of Quality Test Instruments on display at all leading radio parts and equipment distributors. Signal Generators, Vacuum Tube Voltmeters, Tube Testers, Multi-range Test Sets, etc.

**PRECISION**  
TEST EQUIPMENT  
*Standard of Accuracy*

**PRECISION**  
APPARATUS COMPANY INC.  
92-27 HORACE HARDING BOULEVARD  
ELMHURST 8, NEW YORK

**MANUFACTURERS OF FINE RADIO AND ELECTRICAL TEST EQUIPMENT**

heavy linen paper, reinforced top and bottom, and hinged for hanging. It shows how the electron is freed in electron tubes, basic structural types of electron tubes, action of gas-filled and vacuum tubes, and six primary functions of electron tubes—rectification, amplification, generation, control, changing light into electricity, and changing electricity into radiant energy. Price of the Electron Tube chart is \$2.00. It is available from the Westinghouse Electric Corporation, 306 Fourth Avenue, Pittsburgh 30.

#### Webster Price Correction

The Webster-Chicago Corp. table

Model 60 Record Changer Phonograph described in May "RSD" should have been announced as having a resale price of \$55 and not \$49.50.

#### Ad-A-Shaft Controls

Any one of many popular shafts may be permanently and rigidly attached to any Clarostat Ad-A-Shaft Series AM (Standard) or AT (Tapped) Control simply by inserting it in the slot of the selected control and giving it a sharp blow with a hammer, whereupon it snaps into place permanently.

Made available by Clarostat Mfg. Co., Inc., Brooklyn, N. Y., Ad-A-Shaft Controls come packed in tiny cartons saving shelf space. Also, because any

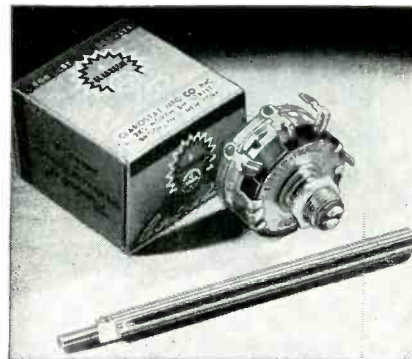

control selected for electrical characteristics can be used with any shaft selected for mechanical characteristics a minimum stock handles maximum requirements. Unused shafts can be exchanged for other types, or additional shafts can be ordered.

#### New Battery Catalog

An attractive 16 page Battery Catalog recently published, may be secured from Willard Storage Bat. Co., 246 E. 131st St., Cleveland 1, Ohio.

Each catalog page features the battery types sold in largest volume for

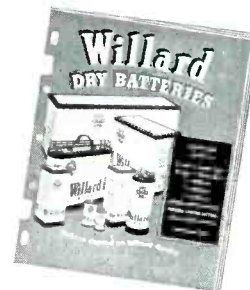

the applications indicated by the page heading. Applications shown in a group illustration. Terminal arrangements are illustrated for all batteries equipped with plug receptacles. Complete and accurate specifications are furnished for the entire Willard Dry Battery Line.

#### New Masco 5-Watt Amplifier

To meet the needs of small halls, dance and entertainment spots and the requirements of solo instrumentalists or small musical groups, Mark Simpson Manufacturing Co., Inc., Long Island City, New York is now producing a new 5-watt musical amplifier of unusual power output.

Known as Masco's MAP-105, it is a self contained, easy-to-carry, light weight system housed in a highly styled two tone fabricoid covered carrying case, with two inputs for mike or instrument, heavy duty 8" Alnico V P.M. speaker and convenient tuck-away compartment for cord.

#### G.E. 3-way Personal

General Electric's new three-way personal radio Model 140 operates on AC, DC or self-contained batteries. It weighs only 5½ pounds with batteries, has four-tubes and selenium rectifier,



**TYPE  
CRO-3A**

## EXTRA SENSITIVITY in this GENERAL ELECTRIC OSCILLOSCOPE

**S**ENSITIVITY over and above ordinary requirements—sensitivity for special or unusual problems—sensitivity that makes the CRO-3A *must* equipment on every serviceman's bench.

Built to do a wide variety of jobs and do them well, the CRO-3A has been designed for simple, easy operation. All controls are conveniently located on the front panel; a daylight viewing screen gives excellent visibility without strain; sweep rates from 20 to 30,000 cycles per second, adjustable by a 7 point switch with vernier for fine adjustment. Portable, the unit is housed in a welded steel case in gray wrinkle finish with etched aluminum front panel. Weight: 25 lbs.

Here are the jobs the CRO-3A can help you to do more rapidly:

- Routine service work
- Study wave shapes and transients
- Determine peak voltages
- Trace electronic tube characteristics
- Determine the speed of small motors at no load or unknown frequencies, when used with a Beat-Frequency Oscillator of proper design.

New Free Booklet on FM Servicing available.

For more information on the CRO-3A and other quality service test equipment write: General Electric Co., Electronics Department, Syracuse 1, New York.

**GENERAL ELECTRIC**

16476



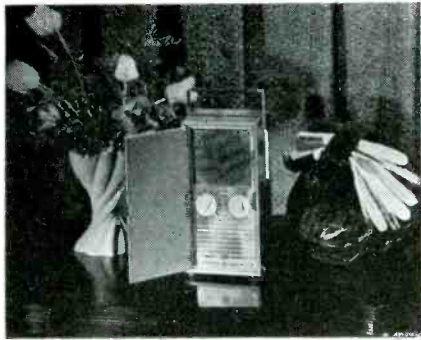

uses a 3½ inch Alnico 5 permanent magnet loudspeaker. Built-in Beam-a-Scope antenna. All operational controls, including switch from batteries to AC-DC, are on aluminum front panel. The set is automatically turned on and off by opening and closing door. Retail price is about \$49.95.

### Ward Di-Pole

The new Ward Folded Di-Pole FM Antenna assembled with Reflector Kit for use in the 88-106 mc band. For complete information about this, and

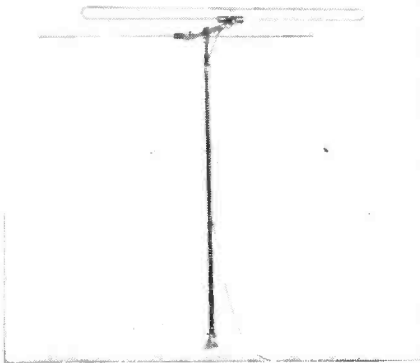

the Ward Straight Di-Pole—which also is available with or without the Reflector Kit, write Ward Products Company, 1523 East 45th St., Cleveland 3, Ohio. Both types also are available for use in the 44-88 mc Television range.

### Remler Convertible

The new Scottie Convertible is said by the maker to be "the World's Smallest Radio Phonograph". It measures 6¾" x 7" x 10".

A constant-speed, worm-gear drive motor assures precision speed regulation. Both the turntable and motor are mounted in rubber to eliminate vibra-



tion. It plays 10 or 12 inch records. The tone arm has a crystal pick-up and a permanent needle. The Convertible has five tubes plus a rectifier of the selenium type. A single switch controls the volume for both radio and phonograph. The phonograph shuts off automatically when the lid is lowered, which makes it impossible to leave the motor on when the cover is down. The loop antenna is enclosed in the lid.

A fused wall plug insures safety. Housed in a plastic case in ivory and ebony, list price \$64.95. For further information, write Remler Company, Ltd., 2101 Bryant St., San Francisco 10, Calif.

### Rauland Antennas

The first of a new line of FM and Television antennas has been released

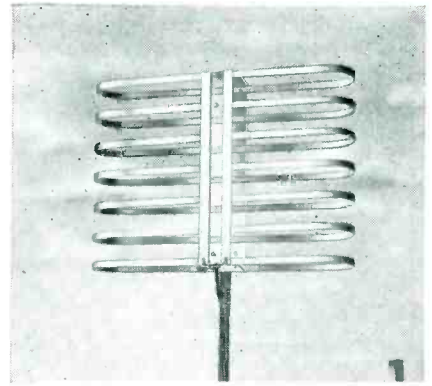

by the Rauland Corporation of 4245 North Knox Avenue, Chicago, Illinois. Model 150, designed specifically for use on the 88 to 108 mc FM Band, has an omni-directional pickup pattern

**Another MASCO  
PRIZE WINNING  
PACKAGE OF  
PROFIT**  
**Dual Speed  
PORTABLE  
DISC RECORDER  
With Single Play-Back**



### NEW! With Every Facility of the Professional Type Recorder

Sensation of the Chicago Show... because distributors and dealers recognized the big market for this disc recorder and play back... broadcast stations, talent agents, schools, churches, lecture halls, night clubs and people who entertain at home.

It has 3 separate input jacks, providing for 1. direct recording from microphone, 2. direct recording electronically from a phonograph (dubbing), 3. direct recording from radio to record. Selector switch on panel allows for simple change of function.

Volume level indicator eye assures accurate recording level. Separate volume and tone controls allow for any desired volume or tone setting.

Complete with heavy duty 6 in. P.M. Alnico V Speaker and kit of 5 matched tubes

List Price \$135.00

Add 5% West of Rockies

Contact your local Masco distributor for immediate delivery. For descriptive literature or other information write directly to factory, Dept. E

**COMPLETE  
SELF-CONTAINED  
DUAL SPEED  
DISC RECORDER...**

**...AND PLAY-BACK  
WITH BUILT-IN  
AMPLIFIER  
AND SPEAKER**

### FEATURES

- Combined recorder and P.A. system.
- Recording and play-back both 78 and 33½ RPM.
- Electronic volume level indicator.
- Heavy duty 6 in. Alnico V Speaker.
- Separate volume and tone controls.
- Five tubes including rectifier.
- Separate jack for external speaker.
- Adjustable cutting head.
- Separate motor switch.
- Fused circuit.

**MASCO**

**MARK SIMPSON MANUFACTURING CO., Inc.**  
32-28 49th Street, Long Island City 3, N.Y.



**SOUND SYSTEMS and Accessories**

RAvenswood 8-5810-1-2-3-4

Thousands of  
Satisfied  
Users!



**TRANSVISION**

**TELEVISION  
KIT... A High Quality  
TELEVISION RECEIVER**

ready for Easy,  
Rapid Assembly

Features the Brilliant  
**LECTROVISION Picture Tube!**



ENGINEERED  
BY  
TELEVISION  
SPECIALISTS

Easy-to-Assemble: No knowledge of television required. COMPLETE easy-to-follow INSTRUCTION SHEET gives you all the knowledge you need.

This Kit INCLUDES SOUND, all component parts, and the following:—

Specially designed Television Antenna . . . A \$30.00 Brilliant Lectrovision seven-inch Picture Tube, plus ALL other tubes . . . Pre-tuned R-F unit . . . Finished front panel . . . All solder, wire, and 60 ft. of low loss lead-in cable.

Operates on 110V.; 50-60 cycles AC. Complete with ALL tubes, Net \$159.50 (fair traded)

**IMMEDIATE DELIVERY!**

We believe that the comparative quality of this set is superior to other available sets. It has been acclaimed by major television schools.



**CABINET for  
TRANSVISION  
Television Kit**

Made of selected grain wood, with beautiful hand-rubbed walnut finish. Accessory Kit for Mounting Included at No Extra Charge. Overall size: 17 1/8" deep; 19 1/4" wide; 15 3/8" high. Net \$29.95

**DEALERS!** Cash in on this Kit! Ideal for making your own Custom-Built Television Receiver.

SEE YOUR LOCAL DISTRIBUTOR.  
or, for further information, write to:

**TRANSVISION, INC.** Dept. R.S.D.  
385 North Ave.—New Rochelle, N. Y.

which results in signals being received from all directions, requiring no special orientation.

Made of all aluminum construction and small in size contributing to low wind resistance, in local metropolitan areas the antenna can be located indoors satisfactorily.

**"Midget" Mike**

In conjunction with its new line of Recordios, Wilcox-Gay has a new microphone, the "Midget" which is featured on all Recordia consoles and table models. The new microphone is light and compact, fits into the palm of the hand. It utilizes a diaphragm type crystal unit housed in a light die cast housing. A glass cloth grill screen is used.

**FREQUENCY  
MODULATION**

[from page 13]

line must present very low-loss characteristics in the VHF range. Recent developments in low-loss transmission lines include a spaced, polyethylene-insulated, two-wire line of 300 ohms characteristic impedance. In tests with the Westinghouse Stratovision FM antenna, it was found that maximum signal level at the receiver input terminals was obtained with this new "twin-lead" line as compared with standard 50 and 70 ohm coaxial and twisted pair lines. In extremely noisy locations, however, the 300 ohm line will pick up slightly more noise than the coaxial type. In making installations in such very noisy areas, the coaxial-type transmission line may be used with some sacrifice of signal strength at the receiver input.

minals was obtained with this new "twin-lead" line as compared with standard 50 and 70 ohm coaxial and twisted pair lines. In extremely noisy locations, however, the 300 ohm line will pick up slightly more noise than the coaxial type. In making installations in such very noisy areas, the coaxial-type transmission line may be used with some sacrifice of signal strength at the receiver input.

**INSTALLING AN FM  
ANTENNA**

An FM antenna should be installed as high as possible, in the clear, away from close proximity to metal roofs and other metallic objects. The dipole antenna is slightly directional and is most sensitive to FM signals when rotated to a position *broadside* to the FM station. The antenna can usually be rotated to the position which gives best signal pickup on the various stations across the band. As the sensitivity pattern of the dipole is that of a figure 8, it will be necessary to rotate the antenna only 90° for changing from minimum to maximum sensitivity. Tests have proved that in most cases little difference in signal strength is noticed when the antenna is rotated, provided that the signal is strong. In most installations the antenna will

**LOOK  
to  
WARD**

for  
**OUTSTANDING  
FM  
Antennas**

Ward FM antennas stand head and shoulders above the field for value. Available in straight or folded dipole types (with or without reflector kit), they adapt easily to varying individual requirements. Providing the maximum electrical efficiency needed for finest FM reception, they are easy to install securely. Their trouble-free operation assures you extra profits. Write for free catalog today.

**WARD** *Aerials*

THE WARD PRODUCTS CORPORATION  
1523 EAST 45th STREET, CLEVELAND 3, OHIO

EXPORT DEPARTMENT: C. W. Brandes, Manager, 4900 Euclid Ave., Cleveland 3, Ohio  
IN CANADA: Atlas Radio Corp., 560 King Street W., Toronto 1, Ontario, Canada



# BURGESS Builds Flashlight Battery Profits

Expertly merchandised in colorful, buy-appealing packs. Nationally advertised to 40,000,000 buyers every month... Burgess quality is known to millions. Order These Merchandising Displays Today.

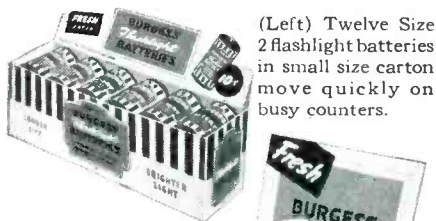

(Left) Twelve Size 2 flashlight batteries in small size carton move quickly on busy counters.

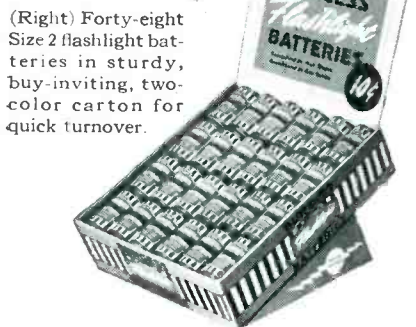

(Right) Forty-eight Size 2 flashlight batteries in sturdy, buy-inviting, two-color carton for quick turnover.



**BURGESS**  
IS THE COMPLETE QUALITY LINE

# BURGESS BATTERIES

be orientated to provide best reception on desired weak stations and left in that position.

The 300-ohm transmission line is fairly sensitive to metallic objects. Stand-off insulators to prevent the transmission swinging or rubbing against the metal mast should be used. The three-foot section of transmission line between the stand-off insulator and the center of the dipole should be twisted *three times* and drawn tight through the insulator. The purpose in twisting the transmission line between the dipole center and the stand-off insulator is to maintain electrical balance between each wire of the transmission line and the metal mast. This nullifies the effect of the metal mast in the transmission line field, thus preventing loss of the r-f signal energy.

The section of transmission line between the stand-off insulator and the FM receiver, input terminals should be kept flat and drawn fairly tight. Do not permit the line to swing or rub against roof edges, walls or shrubbery. The transmission line may be dressed against a *dry* wooden baseboard or wall and the line secured by driving a small metal brad through the center of the plastic dielectric and into the wood. The brads should be spaced about one or two feet apart. Do not use thumb or carpet tacks; the large metallic head may short circuit the two wires of the line or may cause serious signal losses due to a change in the characteristic impedance of the line.

Use just sufficient length of line to reach the antenna terminals without coiling; any excess line should be cut away. At these extremely high frequencies, tests have shown that two or three turns or loops in the transmission line are sufficient to reduce the received signal strength 25 to 50 per cent.

## TELEVISION QUIZ ANSWERS

**Do NOT read or study these answers until you have finished marking down your answers to the "Quiz" given on pages 10 and 11 of this issue. When that is done, compare your answers to these correct ones.**

### ANSWERS

- 1-b; 2-c; 3-b; 4-b; 5-a; 6-a; 7-c; 8-b; 9-c; 10-b.  
11-b; 12-c; 13-b; 14-a; 15-c; 16-b; 17-a; 18-c; 19-a; 20-b.  
21-a; 22-b; 23-a; 24-b; 25-a; 26-b; 27-c; 28-a; 29-a; 30-c.  
31-c; 32-a; 33-b; 34-b; 35-c; 36-b; 37-a; 38-c; 39-a; 40-b.  
41-a; 42-a; 43-a; 44-b; 45-b; 46-a; 47-a; 48-a; 49-a; 50-c.

**"HOT"**  
**ON THE JOB BUT**  
**COOL**  
**TO HANDLE...**



## SOLDERING IRONS

**F**OR service men, mechanics of all types and "handy" men who want quality tools... G-E Calrod Soldering Irons meet every requirement.

### CALROD ELEMENT

Cartridge type, insulated with highly compacted magnesium oxide which maintains full insulation properties and dependably protects against grounding. The Calrod element conducts heat so rapidly that there is little temperature drop from the resistance wire. High efficiency and quick recovery permit fast work with minimum loss of time.

### CALORIZATION

Much longer life can be expected from the calorized tip. Calorization also makes tip removal easy and prevents "freezing in". Corrosion of the tip is greatly retarded by calorization.

### HEAT RESERVOIR

An ample heat reservoir is provided by a calorized copper heat conductor which also serves as the tip holder.

### STAINLESS STEEL BARREL

There is very low heat loss through the barrel because stainless steel has less than half the conductivity of plain steel. The barrel will withstand extremely hard usage without ill effects.

### COOL HANDLE

The smooth, plastic handle remains cool to the touch. The heat is in the working tip where it belongs.

For complete information write: General Electric Company, Electronics Department, Syracuse 1, N. Y.

169-FG

**GENERAL ELECTRIC**

## IN AND AROUND THE TRADE

[from page 6]

tity of television receivers. There will be two types of dealerships, Mr. Fisher explained:

"First, the servicing dealer, the type of retail organization which has complete shop facilities as approved by General Electric television engineers, and, most important, which is staffed by technical service personnel, adjudged proficient to handle completely the installation and service of Gen-

eral Electric television receivers in the field.

"Second, the non-service dealer will be that type of retail outlet which does not at the moment qualify as above, but will act solely in the capacity of a sales agency. In this case, however, a factory approved servicing agency will be provided to handle the installation and service in conformity with the consumer service contract."

### Insuline Item

The ICA Interference Suppressor Set is a brand new packaged auto radio accessory item, produced by the Insuline Corporation of America, 36-02 35 Ave., Long Island City, N. Y. Each unit comes in separate packages and the necessary condensers, suppressors, etc. needed to eliminate auto radio noises, and insure clear reception. There's a set for every type of car—old and new.

They are packed in a colorful display carton for quick and convenient sale. Advance interest indicates an enthusiastic sales response. Descriptive literature and prices available upon request to ICA.

### Weston Bulletin

A new publication, "Weston Engineering Notes," which will serve as a medium to provide pertinent application engineering information for users of electrical indicating instruments, has been inaugurated by the Engineering Laboratories of the Weston Electrical Instrument Corporation. The first issue featured articles entitled "The Galvanometer and the Bridge" and "Copper Oxide Rectifiers as Used in Measuring Instruments". It is expected this new publication, being distributed free to a large mailing list, will make its appearance on a bi-monthly basis.

Anyone whose interests include instrumentation problems will be placed on the mailing list if a request is sent to John Parker, editor, Weston Electrical Instrument Corporation, Newark 5, New Jersey.

### Needle Merchandiser

As a point-of-sale attraction, Microtone Company's Silver Sapphire needle is attached to the cover of a Record Log, a booklet intended for listing records and albums. Instructions for indexing records are included with its 24 pages of ruled spaces for entries. The idea is that the plastic-bound Log with simulated pin-seal leather cover is an item every record fan will want to own, to say nothing of the needle itself. The "package" is displayed on

**ENDS Miniature TUBE BREAKAGE**  
Avoids Burning of Hands  
Saves Time and Work

**New AMO  
Miniature  
TUBE PULLER**



• With the growing use of miniature tubes . . . radio men have been seeking a handy tube-saver like this! Now . . . with the AMO . . . miniature tubes can easily be extracted from sockets or inserted . . . in hard-to-reach places . . . without fear of breakage, burning of hands, or loss of time!

Because the AMO is so handy and so durable . . . because it is so usable again and again and costs so little . . . no radio man should be without one!

Let this marvelous tool build profits for you. Order now—or write for further information. Available at established distributors.

Made by Oliver Tool Co., Chicago 39  
National Sales Representatives:  
**SALESCRAFTERS, INC.**  
510 N. Dearborn St., Chicago 10, Illinois  
**PAYS FOR ITSELF OVER AND OVER AGAIN!**

**Makes it Easy  
to Remove or Insert  
MINIATURE TUBES  
such as 6Ag5, 50B5, etc.**

AMO is simple to operate. When extended in the finger tips, it can reach places where fingers alone would find difficulty. To extract tubes, simply press AMO down on tube, and lift up. Tube is then released by pressing release button. To insert tubes into hard-to-reach places, place tube in AMO holder, press into socket, and release. That's all!

Made with heat-resistant rubber cap, aluminum body, and handy thumb-operated plunger release.

*Does a Lot  
for Just  
a Little!*

**\$1.50  
LIST**  
Subject to usual  
trade discount

## RIDER RADIO BOOKS

**Builders of Successful Servicing**

**You Must Keep  
Up-to-date to  
Keep Ahead!**

### THREE OF RIDER'S LATEST!

- Inside the Vacuum Tube  
Solid concept of theory  
and operation . . . \$4.50
- Understanding Microwaves  
Provides foundation for  
understanding . . . 6.00
- Radar  
Entertaining, revealing,  
in lay language . . . 1.00

### STANDARD RIDER BOOKS

- |   |   |
|---|---|
| <ul style="list-style-type: none"> <li>The Cathode Ray Tube<br/>at Work<br/>Accepted authority on<br/>subject . . . \$ 4.00</li> <li>Frequency Modulation<br/>Gives principles of FM<br/>radio . . . 2.00</li> <li>Servicing by Signal<br/>Tracing<br/>Basic method of radio<br/>servicing . . . 4.00</li> <li>The Meter at Work<br/>An elementary text on<br/>meters . . . 2.00</li> </ul> | <ul style="list-style-type: none"> <li>Vacuum Tube Voltmeters<br/>Both theory and practice \$2.50</li> <li>Automatic Frequency<br/>Control Systems<br/>—also automatic tuning<br/>systems . . . 1.75</li> <li>A-C Calculation Charts<br/>Two to five times as fast<br/>as slide rule . . . 7.50</li> <li>The Oscillator at Work<br/>How to use, test and<br/>repair . . . 2.50</li> </ul> |
|---|---|

**Order  
from  
Your  
Jobber  
Today**

- Hour-A-Day-with-Rider Series —
- On "Alternating Currents in Radio  
Receivers"
  - On "Resonance & Alignment"
  - On "Automatic Volume Control"
  - On "D-C Voltage Distribution" \$1.25 each

**JOHN F. RIDER PUBLISHER, INC.**, 404 Fourth Avenue, New York 16, N. Y.  
**PUBLISHER OF RIDER MANUALS**

Export Division: Rocke-International Corp. 13 E. 40th Street New York City Cable: ARLAB

on 2-color counter easel, available to dealers from the company at 114 Manhattan St., Stamford, Conn.

### Simplify Auto Radio Service

A new line of auto radio service manuals has just been prepared for all auto radio members of the "Philco Service" organization in this country and abroad, announces Robert Herr, vice president in charge of the Service Division of Philco Corporation.

"By dividing the receiver circuit into four sections with selected tests for each, these manuals allow the servicemen rapidly and easily to isolate the point of repair as to section and component within the section," said Mr. Herr. "Comprehensive service courses in our factories and distributor service courses in the field will now be augmented by these rapid repair guides. In addition factory field engineers will continue to be in personal contact with our service people everywhere. By this service plan we can be sure that experience gained all along the line from factory to service station will be readily available to the owners of Philco auto radio sets."

### Sell FM Antenna If Needed, Dealers Told

"FM is here to stay, but it's not a Utopian market," says J. T. Dalton, general sales manager for radio and television, Bendix Radio Division, Bendix Aviation Corporation. "These words are inspired by a realistic approach to the antenna market," explains Dalton, who wants to sell FM for its merits and not just to add sales.

"Don't sell FM radios without antennas when there is definite question about reception. Check your local FM stations for their primary broadcasting areas, then explain the antenna story whenever your prospect or customer lives beyond them. Insure his listening pleasure and you help assure FM's future in your market," the Bendix Radio sales head pointed out.

"FM waves, transmitted on high frequencies with light beam characteristics, are subject to shadow effects from the earth's contour and buildings," he stated. "The outside antenna serves to get necessary height for signal reception as well as to overcome some of the handicaps of shielded construction in modern buildings."

### RCA TUBE

Sales Aid Catalogs on RCA, RCA Victor, and Cunningham tube brands, designed to give distributors and their dealer and servicemen customers a concise summary of the range of tube promotional material have been released to distributors, announces Julius

Haber, manager, Tube Advertising and Sales Promotion. The catalogs which are in color, describe each promotional item in detail, and stress the importance and prestige of dealer and serviceman identification with the best known names in radio.

Included are window, counter and interior store displays, indoor and outdoor signs, printed Scotch tape, service coats, test stickers, printed letterheads and envelopes, rubber stamps for imprinting the manufacturer's literature, billheads, printed gummed wrapping tape, direct mail cards, ad mats, technical literature, and service publications.

### St. Louis Mikes

The recently established St. Louis Microphone Company will move into its new building at 2726-28 Brentwood Boulevard, St. Louis, Mo., the first of August. The line of dynamic microphones includes a rugged outdoor mike, aircraft noise-cancelling dynamic, noise-cancelling differential dynamic, a dynamic color-mike in plastic, as well as FM, cardioid, ham and other mikes.

Representatives for the St. Louis line of microphones are now being lined up. Complete literature on St. Louis Microphones will be sent upon request.

## NUMBERS 4 and 5 OF THE WALSCO Hit Parade

THE SENSATIONAL, NEW, SCIENTIFIC

### WALSCO STANDARD TEST RECORD

FOR IMMEDIATE . . . ACCURATE . . . AUDIBLE ADJUSTMENT OF RECORD CHANGERS AND COIN OPERATED PHONOGRAPHS . . . . . SOLVES THE PROBLEM OF ADJUSTING PICKUP AND TRIPPING MECHANISM THROUGH

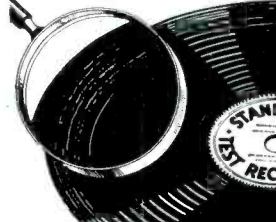

- Three Tone lead-in grooves permits immediate adjustment to proper set down position of the pick-up through audible means.
- Made to RMA and NAB standards.
- Record plays in less than 40 seconds.
- Audio tone at end of record indicates proper adjustment of tripping action.

The WALSCO Standard Test Record saves time and increases efficiency in the adjustment of record changers and coin operated phonographs. Write for full information.

**WALSCO products**  
Help The Radio Man  
WALTER L. SCHOTT CO. BEVERLY HILLS CALIF. CHICAGO 5, ILL.

### WALSCO UNIBELT THE UNIVERSAL DIAL DRIVE BELT CAN BE CUT TO FIT ANY DIAL DRIVE

Will not Slip or Stretch

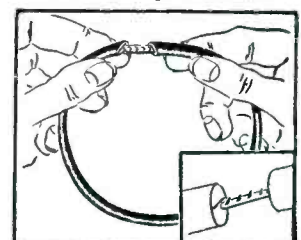

"UNIBELT" comes in 5-foot length spools and can be installed without taking dial mechanism apart. A real time and money saver. Eliminates the need for stocking numerous sizes of belts.

Free sample and literature. Write to Dept. 7D.

## Precision Built for Precision Work...

### VACO Break-proof, Shock-proof Screw and Nut Drivers

Top quality in tools has always been a "must" in radio. Only precision built equipment prevents burred screw slot edges . . . provides sureness in making delicate adjustments . . . draws metal or wood firmly together. Break-proof, shock-proof Vaco drivers are your assurance of the right tool for the job. Write for descriptive catalog, today. Vaco Products Co., 317 E. Ontario St., Chicago 11, Ill.



173 TYPES AND SIZES  
**VACO PRODUCTS CO**

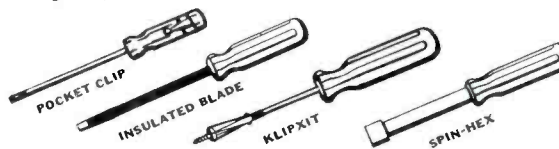

**NEW... Colored Spin-Hex Handle Caps**  
Developed by Vaco to end confusion of similar sizes, speed up production. Color of cap indicates size of driver.



**Cement  
NX Alignment Kit  
Spray Kit —  
Chemical Lab.**

**G-C RADIO SERVICE CEMENT**

Best cement for speaker and radio work. Ideal for cementing replacement cones and repairing rattling and torn cones. Waterproof, fast-drying.

No. 30-2—2 oz. bottle with brush. List 50¢



**G-C NX ALIGNMENT  
KIT**

Approved by armed forces. Handy, aligning and neutralizing kit of 5 tools, leatherette case. No. 5020—List \$6.50

**G-C FELT-KOAT FLOCK FINISH  
SPRAY KITS**

Now it's easy to supply flock for refinishing turntables, cabinets, grilles, etc. Kit contains specially designed spray gun, 2 colors flock, undercoats, thinner, brush, instructions, etc. No. 180-2—List \$10.75



**G-C ELECTRONIC CHEMICAL  
LABORATORY**



Ideal for experimenters, servicemen, etc. 19 different bottles of chemicals in hvy. steel rack (free rack) No. 998—List \$11.12

G-C Products are available at leading distributors

Write for the new G-C 147 and Hardware Catalog of over 4,000 items.

RADIO DIVISION — DEPT. L

**GENERAL CEMENT Mfg. Co., Rockford, Ill., U. S. A.**  
Manufacturers of over 3,000 products  
Sales offices in principal cities

**Ad Index**

Burgess Battery Co. ....	33
Concord Radio Corp. ....	36
Federal Tel. & Radio Corp. ....	5
General Cement Mfg. Co. ....	36
General Elec. Co. (Components) .....	33
General Elec. Co. (Test Equip.) .....	30
General Elec. Co. (Tube Div.) .....	2
General Industries Co., The .....	28
Jensen Manufacturing Co. ....	27
Maguire Industries, Inc. ....	Cover 3
Mallory, & Co., Inc., P. R. ....	Cover 2
McMurdo Silver Co. ....	6
Oliveri Tool Company .....	34
Precision Apparatus Co., Inc. ....	29, 36
Racon Electric Co., Inc. ....	7
Radio Music Corp. ....	28
R C A (Tube Div.) ....	Cover 4
R C A (Test Equip. Div.) .....	9
Rider, Publisher, Inc., John F. ....	8, 34
Sams, & Co., Inc., Howard W. ....	1
Schott Co., Walter L. ....	35
Simpson, Mfg. Co., Inc., Mark .....	31
Sprague Products Co. ....	25
Standard Transformer Corp. ....	19
Supreme Instruments Corp. ....	26
Sylvania Electric Products Inc. ....	17
Tradio, Inc. ....	36
Transvision, Inc. ....	32
Triplet Elec Instrument Co. ....	25
Vaco Products Co. ....	35
Ward Leonard Electric Co. ....	26
Ward Products Corp. ....	32
Wright, Inc. ....	36

**Opportunity Knocks**

**Build Your  
Own Business  
NOW!**



With TRADIO . . . the radio FUNCTIONALLY DESIGNED for coin operation in Hotels, Motels, Stopovers, Clubs, Hospitals, Stations, etc. Big Earnings . . . Steady Income . . . No Clock To Punch . . . Full or Part Time!

• **QUANTITY DELIVERIES DAILY**  
Get In On The Ground Floor In America's Fastest Growing Industry While It Is Still Young!

• **ONLY SMALL INVESTMENT NEEDED**  
Send For Complete Information Today . . . No Routes Sold.

Dept. RSD

**WRITE TO TRADIO, Inc.** Asbury Park, N.J.  
TO **RIGHT NOW!**

**S.S.S.**

**"Servicing by Signal Substitution"**

Learn about this modern dynamic approach to radio servicing with ONLY BASIC TEST EQUIPMENT.

. . . Fully described in a 120 page book available from your Precision Distributor or factory at 35¢.

. . . Schools are invited to inquire regarding quantity orders from our Educational Division.

**PRECISION  
APPARATUS COMPANY INC.  
ELMHURST 3, N. Y.**

Manufacturers of Fine Test Equipment  
RADIO • TELEVISION • ELECTRICAL • LABORATORY

**\$1.00 to \$5.00 PAID  
for "SHOP NOTES"**

Write up any "kinks" or "tricks-of-the-trade" in radio servicing that you have discovered. We will pay from \$1 to \$5 for such previously unpublished "SHOP NOTES" found acceptable. Send your data to "Shop Notes Editor," RADIO SERVICE DEALER, 342 Madison Ave., New York 17, N. Y. Unused manuscripts cannot be returned unless accompanied by stamped and addressed return envelope.

**LCETI**

**new**



**free**

**Featuring Outstanding Values in:  
RADIO PARTS • RADIO SETS  
RECORD CHANGERS • PLAYERS  
HAM GEAR • AMPLIFIERS • TESTERS**

This is it—the new 1947 Concord Catalog—a vast, complete selection of everything in Radio and Electronics—thousands of items available for IMMEDIATE SHIPMENT from CHICAGO or ATLANTA—hundreds now available for the first time—featuring new, latest 1947 prices. See new LOWER prices on RADIO SETS, PHONO-RADIOS, RECORD CHANGERS, RECORD PLAYERS, PORTABLES, AMPLIFIERS, COMPLETE SOUND SYSTEMS, TESTERS. See latest listings of standard, dependable lines of radio parts and equipment—tubes, condensers, transformers, relays, etc. Write for FREE COPY—NOW! Address Dept. K-77.

TIME PAYMENTS: Write us for details of time payment plan on Communications Receivers, Amplifiers, Test Equipment, Radios, Phono-Radios, etc.

**CONCORD  
RADIO CORPORATION**  
LAFAYETTE RADIO CORPORATION  
CHICAGO 7, ILL. ATLANTA 3, GA.  
302 W. Jackson Blvd. 255 Peachtree St.

**VERIFIED SPEAKERS**

*"They speak for themselves"*

**WRIGHT**

2235 University Avenue

Inc.

St. Paul 4, Minnesota

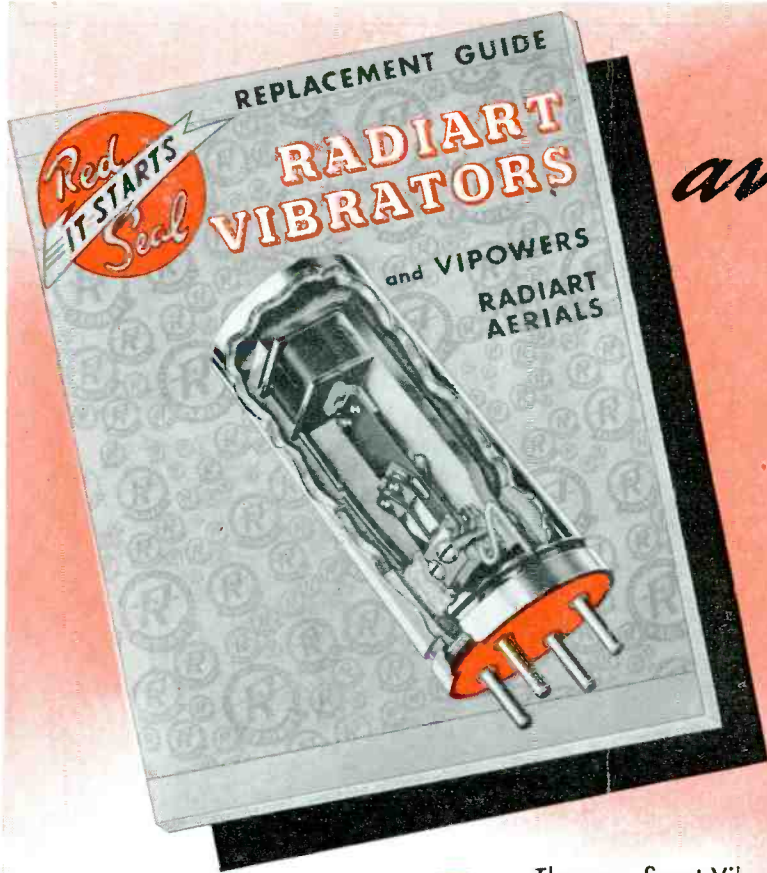

*available NOW*

THE NEW 1947  
**RADIART**  
**VIBRATOR**  
**GUIDE**  
 AND CATALOG

**FREE**

The very finest Vibrator Guide ever offered to the service field. Head and shoulders over any similar handbook, this new 1947 edition is crammed with every conceivable fact relative to the efficient servicing of auto radio power supplies. The most complete vibrator cross index ever compiled; a 23 page replacement list by brand names, buffer circuit diagrams, complete vibrator installation instructions, a six page article on the theory and use of the vibrator written by a leading authority; vibrator indexes by types, by numbers and by base diagrams...all this and much more is contained in the pages of this valuable manual. Designed to simplify the present-day problems of vibrator servicing, this handbook is an invaluable addition to any service library. Send for your free copy today.

*Radiart*

**ELECTRONIC DISTRIBUTOR & INDUSTRIAL SALES DEPARTMENT**

MAGUIRE INDUSTRIES, INC. • 936 N. MICHIGAN AVE. • CHICAGO 11, ILLINOIS  
 EXPORT DIVISION • SCHEEL INTERNATIONAL. 4237 N. LINCOLN AVE., CHICAGO 18, ILL. • CABLE HARSHEEL

ELECTRONIC DISTRIBUTOR & INDUSTRIAL SALES DEPARTMENT  
 MAGUIRE INDUSTRIES, INC. • 936 N. MICHIGAN AVE. • CHICAGO 11, ILL.

PLEASE SEND MY FREE COPY OF THE NEW RADIART VIBRATOR  
 GUIDE AND CATALOG, POSTPAID, TO THE ADDRESS BELOW:

NAME \_\_\_\_\_  
 STREET \_\_\_\_\_  
 CITY \_\_\_\_\_ STATE \_\_\_\_\_

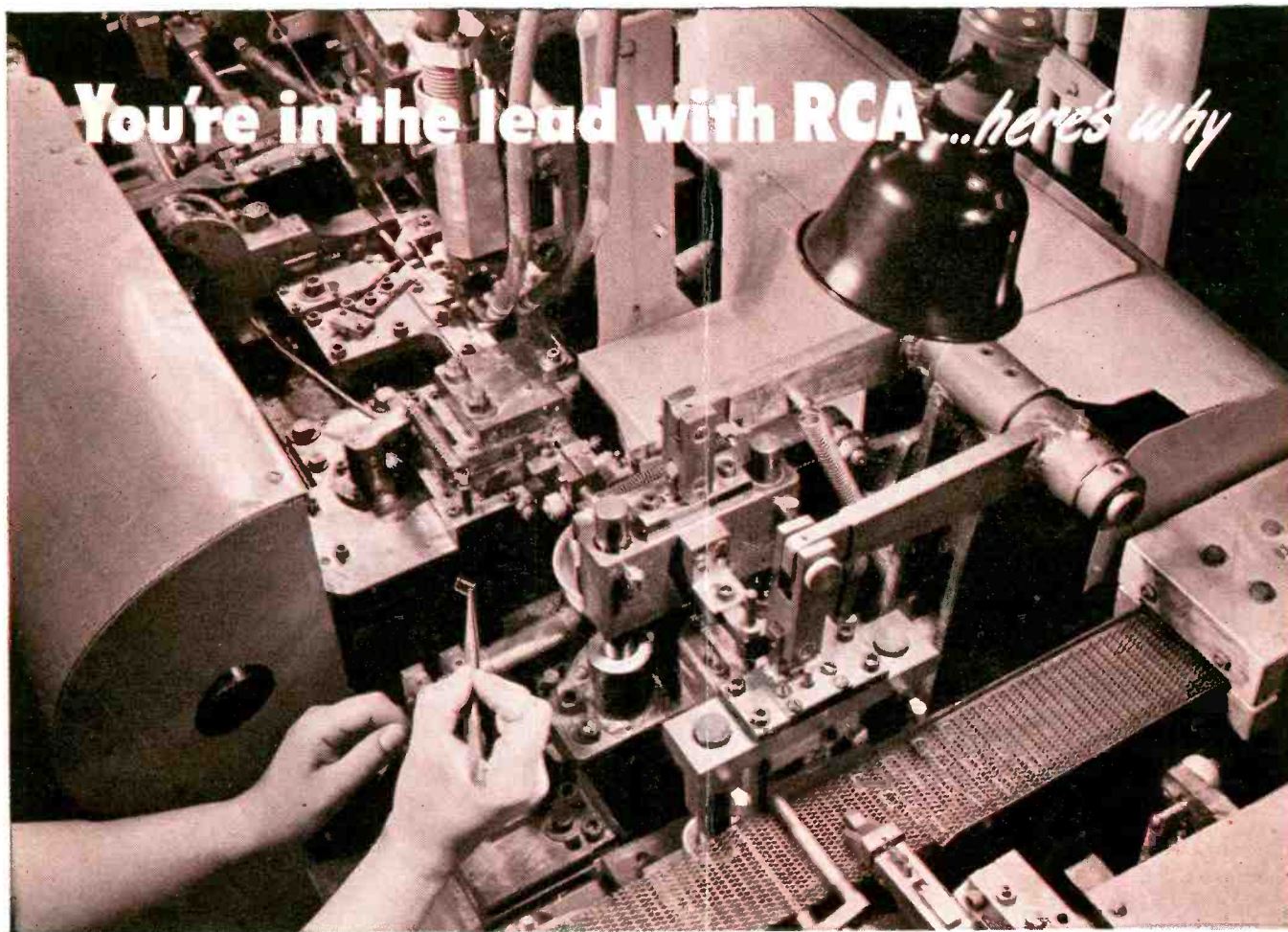

**You're in the lead with RCA** ... *here's why*

*Automatic high-speed getter machine operation—  
a tube manufacturing technique pioneered by RCA.*

# Manufacturing...



## millions of tubes with uniform, dependable quality

The ultra-modern RCA tube plants produce millions of tubes, hundreds of types . . . and this tremendous production is maintained day in and day out with standards of uniform quality that have always been a byword in the industry.

The secret? RCA's engineers are constantly designing ingenious new tube-making machinery, and improving manufacturing techniques to set the pace in this fast-moving radio-electronics industry. Hundreds of precision, mass-production machines, such as that shown above . . .

RCA designed throughout . . . perform near miracles of intricate manufacturing.

RCA's manufacturing "know-how" works constantly to your advantage. It is backed by the engineering leadership of the greatest name in radio. It accounts for the buying confidence and preference so universally accorded RCA tubes.

Manufacturing "know-how" is still another of the many reasons why *you're in the lead with RCA.*

So push RCA tubes and watch your business grow!

**THE FOUNTAINHEAD OF MODERN TUBE DEVELOPMENT IS RCA**



**TUBE DEPARTMENT**

**RADIO CORPORATION of AMERICA**

**HARRISON, N. J.**